



**COMMONWEALTH OF PENNSYLVANIA  
DEPARTMENT OF ENVIRONMENTAL PROTECTION  
AIR QUALITY PROGRAM**

**TITLE V/STATE OPERATING PERMIT**

Issue Date: November 4, 2022

Effective Date: November 4, 2022

Expiration Date: November 4, 2027

In accordance with the provisions of the Air Pollution Control Act, the Act of January 8, 1960, P.L. 2119, as amended, and 25 Pa. Code Chapter 127, the Owner, [and Operator if noted] (hereinafter referred to as permittee) identified below is authorized by the Department of Environmental Protection (Department) to operate the air emission source(s) more fully described in this permit. This Facility is subject to all terms and conditions specified in this permit. Nothing in this permit relieves the permittee from its obligations to comply with all applicable Federal, State and Local laws and regulations.

The regulatory or statutory authority for each permit condition is set forth in brackets. All terms and conditions in this permit are federally enforceable applicable requirements unless otherwise designated as "State-Only" or "non-applicable" requirements.

**TITLE V Permit No: 13-00001**

Federal Tax Id - Plant Code: 20-0447346-2

**Owner Information**

Name: BEFESA ZINC US INC.  
Mailing Address: 900 DELAWARE AVE  
PALMERTON, PA 18071-2008

**Plant Information**

Plant: BEFESA ZINC US INC./PALMERTON  
Location: 13 Carbon County 13804 Palmerton Borough  
SIC Code: 3341 Manufacturing - Secondary Nonferrous Metals

**Responsible Official**

Name: ERIC STROOM  
Title: DIR OF OPERATIONS - EAST  
Phone: (678) 794 - 7511 Email: eric.stroom@befesa.com

**Permit Contact Person**

Name: JOSEPH FALKO  
Title: EH&S MANAGER  
Phone: (610) 826 - 8714 Email: joe.falko@befesa.com

[Signature] \_\_\_\_\_  
MARK J. WEJKSZNER, NORTHEAST REGION AIR PROGRAM MANAGER



## SECTION A. Table of Contents

### Section A. Facility/Source Identification

Table of Contents  
Site Inventory List

### Section B. General Title V Requirements

- #001 Definitions
- #002 Prohibition of Air Pollution
- #003 Property Rights
- #004 Permit Expiration
- #005 Permit Renewal
- #006 Transfer of Ownership or Operational Control
- #007 Inspection and Entry
- #008 Compliance Requirements
- #009 Need to Halt or Reduce Activity Not a Defense
- #010 Duty to Provide Information
- #011 Reopening and Revising the Title V Permit for Cause
- #012 Reopening a Title V Permit for Cause by EPA
- #013 Operating Permit Application Review by the EPA
- #014 Significant Operating Permit Modifications
- #015 Minor Operating Permit Modifications
- #016 Administrative Operating Permit Amendments
- #017 Severability Clause
- #018 Fee Payment
- #019 Authorization for De Minimis Emission Increases
- #020 Reactivation of Sources
- #021 Circumvention
- #022 Submissions
- #023 Sampling, Testing and Monitoring Procedures
- #024 Compliance Certification
- #025 Recordkeeping Requirements
- #026 Reporting Requirements
- #027 Operational Flexibility
- #028 Risk Management
- #029 Approved Economic Incentives and Emission Trading Programs
- #030 Permit Shield
- #031 Reporting
- #032 Report Format

### Section C. Site Level Title V Requirements

- C-I: Restrictions
- C-II: Testing Requirements
- C-III: Monitoring Requirements
- C-IV: Recordkeeping Requirements
- C-V: Reporting Requirements
- C-VI: Work Practice Standards
- C-VII: Additional Requirements
- C-VIII: Compliance Certification
- C-IX: Compliance Schedule

### Section D. Source Level Title V Requirements

- D-I: Restrictions
- D-II: Testing Requirements
- D-III: Monitoring Requirements
- D-IV: Recordkeeping Requirements
- D-V: Reporting Requirements



## SECTION A. Table of Contents

D-VI: Work Practice Standards  
D-VII: Additional Requirements

Note: These same sub-sections are repeated for each source!

### Section E. Source Group Restrictions

E-I: Restrictions  
E-II: Testing Requirements  
E-III: Monitoring Requirements  
E-IV: Recordkeeping Requirements  
E-V: Reporting Requirements  
E-VI: Work Practice Standards  
E-VII: Additional Requirements

### Section F. Alternative Operating Scenario(s)

F-I: Restrictions  
F-II: Testing Requirements  
F-III: Monitoring Requirements  
F-IV: Recordkeeping Requirements  
F-V: Reporting Requirements  
F-VI: Work Practice Standards  
F-VII: Additional Requirements

### Section G. Emission Restriction Summary

### Section H. Miscellaneous

**SECTION A. Site Inventory List**

Source ID	Source Name	Capacity/Throughput	Fuel/Material
101	KILN #2 - ID FAN EMERGENCY DRIVE ENGINES	5.100 MMBTU/HR	
102	KILN #5 - ID FAN EMERGENCY DRIVE ENGINES	5.100 MMBTU/HR	
103	KILN #1 EMERGENCY GENERATOR (PLAN APPROVAL #13-308-104)	12.000 MMBTU/HR	
149	KILN #1 - WAEZING SYSTEM		
150	KILN #2 - WAEZING SYSTEM		
152	KILN #5 - WAEZING SYSTEM		
230	CZO RECEIVING SILO		
233	EAF DUST FEED HOPPER LOADING - BUILDING 608		
234	EAF DUST TRESTLE CONVEYOR TRANSFER SYS.- BLD. 608		
235A	EAF DUST RAILCAR UNLOADING HOPPER		
235B	EAF DUST HOPPER CONVEYOR TRANSFER		
236	EAF DUST PELLETIZER MATERIAL CONVEYOR TRANSFER - BLDG 608		
237	CZO LOADING SPOUT		
238	F2 KILN DISCHARGE AREA FUGITIVE DUST - KILN #5		
239	F1 KILN DISCHARGE AREA FUGITIVE DUST - KILN #1 AND #2		
242	MATERIAL STOCKPILES WIND EROSION - FUGITIVE DUSTS		
244	ROADWAY USAGE - FUGITIVE DUSTS		
245	KILN FEED BINS		
246	EAF DUST TRESTLE SILOS		
248CTR	CENTER CZO RECEIVING BIN		
248NTH	NORTH CZO RECEIVING BIN		
248STH	SOUTH CZO RECEIVING BIN		
C04	PRODUCT COLLECTOR - KILN #1		
C05	PRODUCT COLLECTOR - KILN #2		
C07	PRODUCT COLLECTOR - KILN #5		
C51	BAGHOUSE - CZO RECEIVING SILO		
C54	B5 BAGHOUSE - EAF DUST FEED HOPPER LOADING -BUILDING 608		
C55	B3 BAGHOUSE - EAF DUST TRESTLE CONVEYOR TRANSFER - BLDG 608		
C56A	B1 BAGHOUSE - EAF DUST RAILCAR UNLOADING HOPPER		
C56B	B2 BAGHOUSE -EAF DUST HOPPER CONVEYOR TRANSFER		
C58	B8 BAGHOUSE - EAF DUST PELLETIZER MAT CONV TRANS BLDG 608		
C59	BAGHOUSE - CZO LOADING SPOUT		
C60	F2 BAGHOUSE		
C61	F1 BAGHOUSE		
C63	BAGHOUSE - KILN FEED BINS		
C64A	BAGHOUSE - EAF DUST TRESTLE SILOS		

**SECTION A. Site Inventory List**

Source ID	Source Name	Capacity/Throughput	Fuel/Material
	RECEIVING SILO BIN VENT A		
C64B	BAGHOUSE - EAF DUST TRESTLE SILOS RECEIVING SILO BIN VENT B		
C64C	BAGHOUSE - EAF DUST TRESTLE SILOS RECEIVING SILO BIN VENT C		
C64D	BAGHOUSE - EAF DUST TRESTLE SILOS RECEIVING SILO BIN VENT D		
C64E	BAGHOUSE - EAF DUST TRESTLE SILOS RECEIVING SILO BIN VENT E		
C67CTR	BIN VENT - CENTER CZO RECEIVING BIN		
C67NTH	BIN VENT - NORTH CZO RECEIVING BIN		
C67STH	BIN VENT - SOUTH CZO RECEIVING BIN		
FML01	#2 FUEL OIL		
FML03	NATURAL GAS		
S04	STACK - #1 PRODUCT COLLECTOR		
S05	STACK - #2 PRODUCT COLLECTOR		
S07	STACK - #5 PRODUCT COLLECTOR		
S51	STACK - LEAD CONCENTRATION CONVEYOR SYSTEM		
S54	STACK - EAF DUST FEED HOPPER LOADING B5 BAGHOUSE		
S55	STACK - EAF DUST TRESTLE CONVEYOR TRANSFER SYSTEM		
S56A	STACK - EAF DUST RAILCAR UNLOADING B1 BAGHOUSE		
S56B	STACK - EAF DUST HOPPER CONVEYOR TRANSFER B2 BAGHOUSE		
S58	STACK - B8 BAGHOUSE		
S59	STACK - CZO LOADING SPOUT		
S60	STACK - F2 KILN DISCHARGE AREA FUGITIVE DUST COLLECTOR		
S61	STACK - F1 KILN DISCHARGE AREA FUGITIVE DUST COLLECTOR		
S63	STACK - KILN FEED BINS		
S64A	STACK A - EAF DUST SILO BIN VENT		
S64B	STACK B - EAF DUST SILO BIN VENT		
S64C	STACK C - EAF DUST SILO BIN VENT		
S64D	STACK D - EAF DUST SILO BIN VENT		
S64E	STACK E - EAF DUST SILO BIN VENT		
S67CTR	STACK - CENTER CZO RECEIVING BIN		
S67NTH	STACK - NORTH CZO RECEIVING BIN		
S67STH	STACK - SOUTH CZO RECEIVING BIN		
Z05	FUGITIVE EMISSIONS - KILN #2 EMERGENCY DRIVE ENGINES		
Z06	FUGITIVE EMISSIONS - KILN #5 EMERGENCY DRIVE ENGINES		
Z07	FUGITIVE EMISSIONS - KILN #1 EMERGENCY GENERATOR		
Z10	FUGITIVE EMISSIONS - MATERIAL STORAGE		

**SECTION A. Site Inventory List**

Source ID	Source Name	Capacity/Throughput	Fuel/Material
Z12	FUGITIVE ROADWAY DUST		

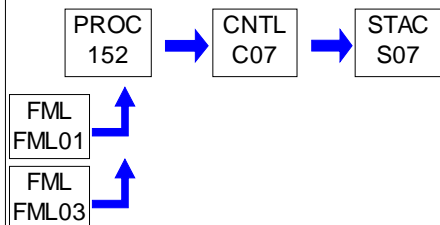
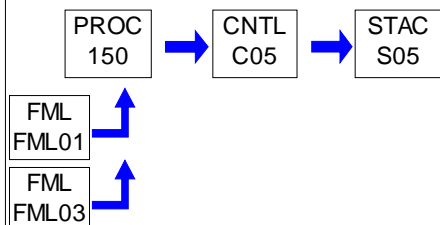
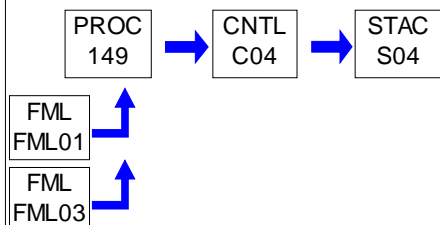
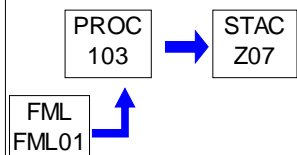
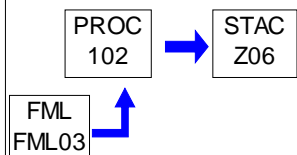
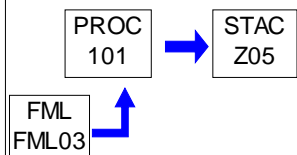
**PERMIT MAPS**



## PERMIT MAPS

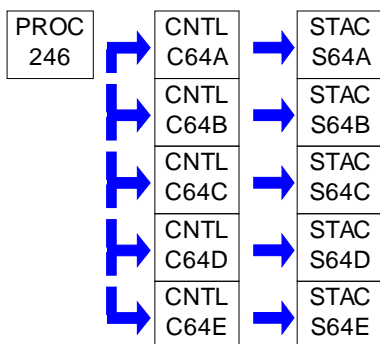
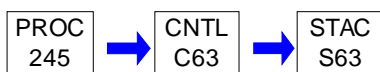
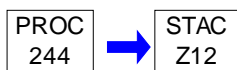
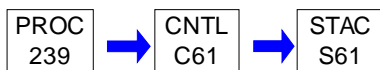
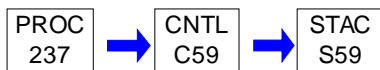
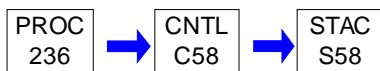
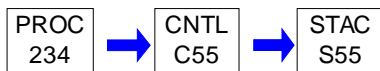
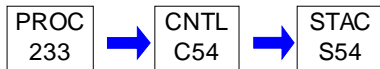
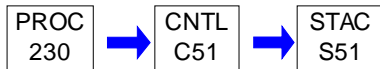



**PERMIT MAPS**

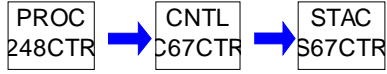



**SECTION B. General Title V Requirements****#001 [25 Pa. Code § 121.1]****Definitions**

Words and terms that are not otherwise defined in this permit shall have the meanings set forth in Section 3 of the Air Pollution Control Act (35 P.S. § 4003) and 25 Pa. Code § 121.1.

**#002 [25 Pa. Code § 121.7]****Prohibition of Air Pollution**

No person may permit air pollution as that term is defined in the act.

**#003 [25 Pa. Code § 127.512(c)(4)]****Property Rights**

This permit does not convey property rights of any sort, or any exclusive privileges.

**#004 [25 Pa. Code § 127.446(a) and (c)]****Permit Expiration**

This operating permit is issued for a fixed term of five (5) years and shall expire on the date specified on Page 1 of this permit. The terms and conditions of the expired permit shall automatically continue pending issuance of a new Title V permit, provided the permittee has submitted a timely and complete application and paid applicable fees required under 25 Pa. Code Chapter 127, Subchapter I and the Department is unable, through no fault of the permittee, to issue or deny a new permit before the expiration of the previous permit. An application is complete if it contains sufficient information to begin processing the application, has the applicable sections completed and has been signed by a responsible official.

**#005 [25 Pa. Code §§ 127.412, 127.413, 127.414, 127.446(e), 127.503 & 127.704(b)]****Permit Renewal**

(a) An application for the renewal of the Title V permit shall be submitted to the Department at least six (6) months, and not more than 18 months, before the expiration date of this permit. The renewal application is timely if a complete application is submitted to the Department's Regional Air Manager within the timeframe specified in this permit condition.

(b) The application for permit renewal shall include the current permit number, the appropriate permit renewal fee, a description of any permit revisions and off-permit changes that occurred during the permit term, and any applicable requirements that were promulgated and not incorporated into the permit during the permit term. The fees shall be made payable to "The Commonwealth of Pennsylvania Clean Air Fund" and submitted with the fee form to the respective regional office.

(c) The renewal application shall also include submission of proof that the local municipality and county, in which the facility is located, have been notified in accordance with 25 Pa. Code § 127.413. The application for renewal of the Title V permit shall also include submission of compliance review forms which have been used by the permittee to update information submitted in accordance with either 25 Pa. Code § 127.412(b) or § 127.412(j).

(d) The permittee, upon becoming aware that any relevant facts were omitted or incorrect information was submitted in the permit application, shall promptly submit such supplementary facts or corrected information during the permit renewal process. The permittee shall also promptly provide additional information as necessary to address any requirements that become applicable to the source after the date a complete renewal application was submitted but prior to release of a draft permit.

**#006 [25 Pa. Code §§ 127.450(a)(4) & 127.464(a)]****Transfer of Ownership or Operational Control**

(a) In accordance with 25 Pa. Code § 127.450(a)(4), a change in ownership or operational control of the source shall be treated as an administrative amendment if:

(1) The Department determines that no other change in the permit is necessary;

(2) A written agreement has been submitted to the Department identifying the specific date of the transfer of permit responsibility, coverage and liability between the current and the new permittee; and,

(3) A compliance review form has been submitted to the Department and the permit transfer has been approved by

**SECTION B. General Title V Requirements**

the Department.

(b) In accordance with 25 Pa. Code § 127.464(a), this permit may not be transferred to another person except in cases of transfer-of-ownership which are documented and approved to the satisfaction of the Department.

**#007 [25 Pa. Code § 127.513, 35 P.S. § 4008 and § 114 of the CAA]****Inspection and Entry**

(a) Upon presentation of credentials and other documents as may be required by law for inspection and entry purposes, the permittee shall allow the Department of Environmental Protection or authorized representatives of the Department to perform the following:

- (1) Enter at reasonable times upon the permittee's premises where a Title V source is located or emissions related activity is conducted, or where records are kept under the conditions of this permit;
- (2) Have access to and copy or remove, at reasonable times, records that are kept under the conditions of this permit;
- (3) Inspect at reasonable times, facilities, equipment including monitoring and air pollution control equipment, practices, or operations regulated or required under this permit;
- (4) Sample or monitor, at reasonable times, substances or parameters, for the purpose of assuring compliance with the permit or applicable requirements as authorized by the Clean Air Act, the Air Pollution Control Act, or the regulations promulgated under the Acts.

(b) Pursuant to 35 P.S. § 4008, no person shall hinder, obstruct, prevent or interfere with the Department or its personnel in the performance of any duty authorized under the Air Pollution Control Act.

(c) Nothing in this permit condition shall limit the ability of the EPA to inspect or enter the premises of the permittee in accordance with Section 114 or other applicable provisions of the Clean Air Act.

**#008 [25 Pa. Code §§ 127.25, 127.444, & 127.512(c)(1)]****Compliance Requirements**

(a) The permittee shall comply with the conditions of this permit. Noncompliance with this permit constitutes a violation of the Clean Air Act and the Air Pollution Control Act and is grounds for one (1) or more of the following:

- (1) Enforcement action
- (2) Permit termination, revocation and reissuance or modification
- (3) Denial of a permit renewal application

(b) A person may not cause or permit the operation of a source, which is subject to 25 Pa. Code Article III, unless the source(s) and air cleaning devices identified in the application for the plan approval and operating permit and the plan approval issued to the source are operated and maintained in accordance with specifications in the applications and the conditions in the plan approval and operating permit issued by the Department. A person may not cause or permit the operation of an air contamination source subject to 25 Pa. Code Chapter 127 in a manner inconsistent with good operating practices.

(c) For purposes of Sub-condition (b) of this permit condition, the specifications in applications for plan approvals and operating permits are the physical configurations and engineering design details which the Department determines are essential for the permittee's compliance with the applicable requirements in this Title V permit.

**#009 [25 Pa. Code § 127.512(c)(2)]****Need to Halt or Reduce Activity Not a Defense**

It shall not be a defense for a permittee in an enforcement action that it would have been necessary to halt or reduce the permitted activity in order to maintain compliance with the conditions of this permit.

**SECTION B. General Title V Requirements****#010 [25 Pa. Code §§ 127.411(d) & 127.512(c)(5)]****Duty to Provide Information**

(a) The permittee shall furnish to the Department, within a reasonable time, information that the Department may request in writing to determine whether cause exists for modifying, revoking and reissuing, or terminating the permit, or to determine compliance with the permit.

(b) Upon request, the permittee shall also furnish to the Department copies of records that the permittee is required to keep by this permit, or for information claimed to be confidential, the permittee may furnish such records directly to the Administrator of EPA along with a claim of confidentiality.

**#011 [25 Pa. Code §§ 127.463, 127.512(c)(3) & 127.542]****Reopening and Revising the Title V Permit for Cause**

(a) This Title V permit may be modified, revoked, reopened and reissued or terminated for cause. The filing of a request by the permittee for a permit modification, revocation and reissuance, or termination, or of a notification of planned changes or anticipated noncompliance does not stay a permit condition.

(b) This permit may be reopened, revised and reissued prior to expiration of the permit under one or more of the following circumstances:

(1) Additional applicable requirements under the Clean Air Act or the Air Pollution Control Act become applicable to a Title V facility with a remaining permit term of three (3) or more years prior to the expiration date of this permit. The Department will revise the permit as expeditiously as practicable but not later than 18 months after promulgation of the applicable standards or regulations. No such revision is required if the effective date of the requirement is later than the expiration date of this permit, unless the original permit or its terms and conditions has been extended.

(2) Additional requirements, including excess emissions requirements, become applicable to an affected source under the acid rain program. Upon approval by the Administrator of EPA, excess emissions offset plans for an affected source shall be incorporated into the permit.

(3) The Department or the EPA determines that this permit contains a material mistake or inaccurate statements were made in establishing the emissions standards or other terms or conditions of this permit.

(4) The Department or the Administrator of EPA determines that the permit must be revised or revoked to assure compliance with the applicable requirements.

(c) Proceedings to revise this permit shall follow the same procedures which apply to initial permit issuance and shall affect only those parts of this permit for which cause to revise exists. The revision shall be made as expeditiously as practicable.

(d) Regardless of whether a revision is made in accordance with (b)(1) above, the permittee shall meet the applicable standards or regulations promulgated under the Clean Air Act within the time frame required by standards or regulations.

**#012 [25 Pa. Code § 127.543]****Reopening a Title V Permit for Cause by EPA**

As required by the Clean Air Act and regulations adopted thereunder, this permit may be modified, reopened and reissued, revoked or terminated for cause by EPA in accordance with procedures specified in 25 Pa. Code § 127.543.

**#013 [25 Pa. Code § 127.522(a)]****Operating Permit Application Review by the EPA**

The applicant may be required by the Department to provide a copy of the permit application, including the compliance plan, directly to the Administrator of the EPA. Copies of title V permit applications to EPA, pursuant to 25 PA Code §127.522(a), shall be submitted, if required, to the following EPA e-mail box:

R3\_Air\_Apps\_and\_Notices@epa.gov

Please place the following in the subject line: TV [permit number], [Facility Name].

**SECTION B. General Title V Requirements****#014 [25 Pa. Code § 127.541]****Significant Operating Permit Modifications**

When permit modifications during the term of this permit do not qualify as minor permit modifications or administrative amendments, the permittee shall submit an application for significant Title V permit modifications in accordance with 25 Pa. Code § 127.541. Notifications to EPA, pursuant to 25 PA Code §127.522(a), if required, shall be submitted, to the following EPA e-mail box:

R3\_Air\_Apps\_and\_Notices@epa.gov

Please place the following in the subject line: TV [permit number], [Facility Name].

**#015 [25 Pa. Code §§ 121.1 & 127.462]****Minor Operating Permit Modifications**

The permittee may make minor operating permit modifications (as defined in 25 Pa. Code §121.1), on an expedited basis, in accordance with 25 Pa. Code §127.462 (relating to minor operating permit modifications). Notifications to EPA, pursuant to 25 PA Code §127.462(c), if required, shall be submitted, to the following EPA e-mail box:

R3\_Air\_Apps\_and\_Notices@epa.gov

Please place the following in the subject line: TV [permit number], [Facility Name].

**#016 [25 Pa. Code § 127.450]****Administrative Operating Permit Amendments**

(a) The permittee may request administrative operating permit amendments, as defined in 25 Pa. Code §127.450(a). Copies of request for administrative permit amendment to EPA, pursuant to 25 PA Code §127.450(c)(1), if required, shall be submitted to the following EPA e-mail box:

R3\_Air\_Apps\_and\_Notices@epa.gov

Please place the following in the subject line: TV [permit number], [Facility Name].

(b) Upon final action by the Department granting a request for an administrative operating permit amendment covered under §127.450(a)(5), the permit shield provisions in 25 Pa. Code § 127.516 (relating to permit shield) shall apply to administrative permit amendments incorporated in this Title V Permit in accordance with §127.450(c), unless precluded by the Clean Air Act or the regulations thereunder.

**#017 [25 Pa. Code § 127.512(b)]****Severability Clause**

The provisions of this permit are severable, and if any provision of this permit is determined by the Environmental Hearing Board or a court of competent jurisdiction, or US EPA to be invalid or unenforceable, such a determination will not affect the remaining provisions of this permit.

**#018 [25 Pa. Code §§ 127.704, 127.705 & 127.707]****Fee Payment**

(a) The permittee shall pay fees to the Department in accordance with the applicable fee schedules in 25 Pa. Code Chapter 127, Subchapter I (relating to plan approval and operating permit fees). The applicable fees shall be made payable to "The Commonwealth of Pennsylvania Clean Air Fund" with the permit number clearly indicated and submitted to the respective regional office.

(b) Emission Fees. The permittee shall, on or before September 1st of each year, pay applicable annual Title V emission fees for emissions occurring in the previous calendar year as specified in 25 Pa. Code § 127.705. The permittee is not required to pay an emission fee for emissions of more than 4,000 tons of each regulated pollutant emitted from the facility.

(c) As used in this permit condition, the term "regulated pollutant" is defined as a VOC, each pollutant regulated under Sections 111 and 112 of the Clean Air Act and each pollutant for which a National Ambient Air Quality Standard has been promulgated, except that carbon monoxide is excluded.

**SECTION B. General Title V Requirements**

(d) Late Payment. Late payment of emission fees will subject the permittee to the penalties prescribed in 25 Pa. Code § 127.707 and may result in the suspension or termination of the Title V permit. The permittee shall pay a penalty of fifty percent (50%) of the fee amount, plus interest on the fee amount computed in accordance with 26 U.S.C.A. § 6621(a)(2) from the date the emission fee should have been paid in accordance with the time frame specified in 25 Pa. Code § 127.705(c).

(e) The permittee shall pay an annual operating permit maintenance fee according to the following fee schedule established in 25 Pa. Code § 127.704(d) on or before December 31 of each year for the next calendar year.

(1) Eight thousand dollars (\$8,000) for calendar years 2021—2025.

(2) Ten thousand dollars (\$10,000) for calendar years 2026—2030.

(3) Twelve thousand five hundred dollars (\$12,500) for the calendar years beginning with 2031.

**#019 [25 Pa. Code §§ 127.14(b) & 127.449]****Authorization for De Minimis Emission Increases**

(a) This permit authorizes de minimis emission increases from a new or existing source in accordance with 25 Pa. Code §§ 127.14 and 127.449 without the need for a plan approval or prior issuance of a permit modification. The permittee shall provide the Department with seven (7) days prior written notice before commencing any de minimis emissions increase that would result from either: (1) a physical change of minor significance under § 127.14(c)(1); or (2) the construction, installation, modification or reactivation of an air contamination source. The written notice shall:

(1) Identify and describe the pollutants that will be emitted as a result of the de minimis emissions increase.

(2) Provide emission rates expressed in tons per year and in terms necessary to establish compliance consistent with any applicable requirement.

The Department may disapprove or condition de minimis emission increases at any time.

(b) Except as provided below in (c) and (d) of this permit condition, the permittee is authorized during the term of this permit to make de minimis emission increases (expressed in tons per year) up to the following amounts without the need for a plan approval or prior issuance of a permit modification:

(1) Four tons of carbon monoxide from a single source during the term of the permit and 20 tons of carbon monoxide at the facility during the term of the permit.

(2) One ton of NO<sub>x</sub> from a single source during the term of the permit and 5 tons of NO<sub>x</sub> at the facility during the term of the permit.

(3) One and six-tenths tons of the oxides of sulfur from a single source during the term of the permit and 8.0 tons of oxides of sulfur at the facility during the term of the permit.

(4) Six-tenths of a ton of PM<sub>10</sub> from a single source during the term of the permit and 3.0 tons of PM<sub>10</sub> at the facility during the term of the permit. This shall include emissions of a pollutant regulated under Section 112 of the Clean Air Act unless precluded by the Clean Air Act or 25 Pa. Code Article III.

(5) One ton of VOCs from a single source during the term of the permit and 5.0 tons of VOCs at the facility during the term of the permit. This shall include emissions of a pollutant regulated under Section 112 of the Clean Air Act unless precluded by the Clean Air Act or 25 Pa. Code Article III.

(c) In accordance with § 127.14, the permittee may install the following minor sources without the need for a plan approval:

(1) Air conditioning or ventilation systems not designed to remove pollutants generated or released from other sources.

(2) Combustion units rated at 2,500,000 or less Btu per hour of heat input.

**SECTION B. General Title V Requirements**

(3) Combustion units with a rated capacity of less than 10,000,000 Btu per hour heat input fueled by natural gas supplied by a public utility, liquefied petroleum gas or by commercial fuel oils which are No. 2 or lighter, viscosity less than or equal to 5.82 c St, and which meet the sulfur content requirements of 25 Pa. Code § 123.22 (relating to combustion units). For purposes of this permit, commercial fuel oil shall be virgin oil which has no reprocessed, recycled or waste material added.

(4) Space heaters which heat by direct heat transfer.

(5) Laboratory equipment used exclusively for chemical or physical analysis.

(6) Other sources and classes of sources determined to be of minor significance by the Department.

(d) This permit does not authorize de minimis emission increases if the emissions increase would cause one or more of the following:

(1) Increase the emissions of a pollutant regulated under Section 112 of the Clean Air Act except as authorized in Subparagraphs (b)(4) and (5) of this permit condition.

(2) Subject the facility to the prevention of significant deterioration requirements in 25 Pa. Code Chapter 127, Subchapter D and/or the new source review requirements in Subchapter E.

(3) Violate any applicable requirement of the Air Pollution Control Act, the Clean Air Act, or the regulations promulgated under either of the acts.

(4) Changes which are modifications under any provision of Title I of the Clean Air Act and emission increases which would exceed the allowable emissions level (expressed as a rate of emissions or in terms of total emissions) under the Title V permit.

(e) Unless precluded by the Clean Air Act or the regulations thereunder, the permit shield described in 25 Pa. Code § 127.516 (relating to permit shield) shall extend to the changes made under 25 Pa. Code § 127.449 (relating to de minimis emission increases).

(f) Emissions authorized under this permit condition shall be included in the monitoring, recordkeeping and reporting requirements of this permit.

(g) Except for de minimis emission increases allowed under this permit, 25 Pa. Code § 127.449, or sources and physical changes meeting the requirements of 25 Pa. Code § 127.14, the permittee is prohibited from making physical changes or engaging in activities that are not specifically authorized under this permit without first applying for a plan approval. In accordance with § 127.14(b), a plan approval is not required for the construction, modification, reactivation, or installation of the sources creating the de minimis emissions increase.

(h) The permittee may not meet de minimis emission threshold levels by offsetting emission increases or decreases at the same source.

**#020 [25 Pa. Code §§ 127.11a & 127.215]****Reactivation of Sources**

(a) The permittee may reactivate a source at the facility that has been out of operation or production for at least one year, but less than or equal to five (5) years, if the source is reactivated in accordance with the requirements of 25 Pa. Code §§ 127.11a and 127.215. The reactivated source will not be considered a new source.

(b) A source which has been out of operation or production for more than five (5) years but less than 10 years may be reactivated and will not be considered a new source if the permittee satisfies the conditions specified in 25 Pa. Code § 127.11a(b).

**#021 [25 Pa. Code §§ 121.9 & 127.216]****Circumvention**

(a) The owner of this Title V facility, or any other person, may not circumvent the new source review requirements of 25 Pa. Code Chapter 127, Subchapter E by causing or allowing a pattern of ownership or development, including the

**SECTION B. General Title V Requirements**

phasing, staging, delaying or engaging in incremental construction, over a geographic area of a facility which, except for the pattern of ownership or development, would otherwise require a permit or submission of a plan approval application.

(b) No person may permit the use of a device, stack height which exceeds good engineering practice stack height, dispersion technique or other technique which, without resulting in reduction of the total amount of air contaminants emitted, conceals or dilutes an emission of air contaminants which would otherwise be in violation of this permit, the Air Pollution Control Act or the regulations promulgated thereunder, except that with prior approval of the Department, the device or technique may be used for control of malodors.

**#022 [25 Pa. Code §§ 127.402(d) & 127.513(1)]****Submissions**

(a) Reports, test data, monitoring data, notifications and requests for renewal of the permit shall be submitted to the:

Regional Air Program Manager  
PA Department of Environmental Protection  
(At the address given on the permit transmittal letter, or otherwise notified)

(b) Any report or notification for the EPA Administrator or EPA Region III should be addressed to:

Enforcement & Compliance Assurance Division  
Air, RCRA and Toxics Branch (3ED21)  
Four Penn Center  
1600 John F. Kennedy Boulevard  
Philadelphia, PA 19103-2852

The Title V compliance certification shall be emailed to EPA at R3\_APD\_Permits@epa.gov.

(c) An application, form, report or compliance certification submitted pursuant to this permit condition shall contain certification by a responsible official as to truth, accuracy, and completeness as required under 25 Pa. Code § 127.402(d). Unless otherwise required by the Clean Air Act or regulations adopted thereunder, this certification and any other certification required pursuant to this permit shall state that, based on information and belief formed after reasonable inquiry, the statements and information in the document are true, accurate and complete.

**#023 [25 Pa. Code §§ 127.441(c) & 127.463(e); Chapter 139; & 114(a)(3), 504(b) of the CAA]****Sampling, Testing and Monitoring Procedures**

(a) The permittee shall perform the emissions monitoring and analysis procedures or test methods for applicable requirements of this Title V permit. In addition to the sampling, testing and monitoring procedures specified in this permit, the Permittee shall comply with any additional applicable requirements promulgated under the Clean Air Act after permit issuance regardless of whether the permit is revised.

(b) The sampling, testing and monitoring required under the applicable requirements of this permit, shall be conducted in accordance with the requirements of 25 Pa. Code Chapter 139 unless alternative methodology is required by the Clean Air Act (including §§ 114(a)(3) and 504(b)) and regulations adopted thereunder.

**#024 [25 Pa. Code § 127.513]****Compliance Certification**

(a) One year after the date of issuance of the Title V permit, and each year thereafter, unless specified elsewhere in the permit, the permittee shall submit to the Department and EPA Region III a certificate of compliance with the terms and conditions in this permit, for the previous year, including the emission limitations, standards or work practices. This certification shall include:

- (1) The identification of each term or condition of the permit that is the basis of the certification.
- (2) The compliance status.
- (3) The methods used for determining the compliance status of the source, currently and over the reporting period.
- (4) Whether compliance was continuous or intermittent.

(b) The compliance certification shall be postmarked or hand-delivered no later than thirty days after each anniversary of



**SECTION B. General Title V Requirements**

the date of issuance of this Title V Operating Permit, or on the submittal date specified elsewhere in the permit, to the Department in accordance with the submission requirements specified in Section B, Condition #022 of this permit. The Title V compliance certification shall be emailed to EPA at R3\_APD\_Permits@epa.gov.

**#025 [25 Pa. Code §§ 127.511 & Chapter 135]****Recordkeeping Requirements**

(a) The permittee shall maintain and make available, upon request by the Department, records of required monitoring information that include the following:

- (1) The date, place (as defined in the permit) and time of sampling or measurements.
- (2) The dates the analyses were performed.
- (3) The company or entity that performed the analyses.
- (4) The analytical techniques or methods used.
- (5) The results of the analyses.
- (6) The operating conditions as existing at the time of sampling or measurement.

(b) The permittee shall retain records of the required monitoring data and supporting information for at least five (5) years from the date of the monitoring sample, measurement, report or application. Supporting information includes the calibration data and maintenance records and original strip-chart recordings for continuous monitoring instrumentation, and copies of reports required by the permit.

(c) The permittee shall maintain and make available to the Department upon request, records including computerized records that may be necessary to comply with the reporting, recordkeeping and emission statement requirements in 25 Pa. Code Chapter 135 (relating to reporting of sources). In accordance with 25 Pa. Code Chapter 135, § 135.5, such records may include records of production, fuel usage, maintenance of production or pollution control equipment or other information determined by the Department to be necessary for identification and quantification of potential and actual air contaminant emissions. If direct recordkeeping is not possible or practical, sufficient records shall be kept to provide the needed information by indirect means.

**#026 [25 Pa. Code §§ 127.411(d), 127.442, 127.463(e) & 127.511(c)]****Reporting Requirements**

(a) The permittee shall comply with the reporting requirements for the applicable requirements specified in this Title V permit. In addition to the reporting requirements specified herein, the permittee shall comply with any additional applicable reporting requirements promulgated under the Clean Air Act after permit issuance regardless of whether the permit is revised.

(b) Pursuant to 25 Pa. Code § 127.511(c), the permittee shall submit reports of required monitoring at least every six (6) months unless otherwise specified in this permit. Instances of deviations (as defined in 25 Pa. Code § 121.1) from permit requirements shall be clearly identified in the reports. The reporting of deviations shall include the probable cause of the deviations and corrective actions or preventative measures taken, except that sources with continuous emission monitoring systems shall report according to the protocol established and approved by the Department for the source. The required reports shall be certified by a responsible official.

(c) Every report submitted to the Department under this permit condition shall comply with the submission procedures specified in Section B, Condition #022(c) of this permit.

(d) Any records, reports or information obtained by the Department or referred to in a public hearing shall be made available to the public by the Department except for such records, reports or information for which the permittee has shown cause that the documents should be considered confidential and protected from disclosure to the public under Section 4013.2 of the Air Pollution Control Act and consistent with Sections 112(d) and 114(c) of the Clean Air Act and 25 Pa. Code § 127.411(d). The permittee may not request a claim of confidentiality for any emissions data generated for the Title V facility.



**SECTION B. General Title V Requirements****#027 [25 Pa. Code § 127.3]****Operational Flexibility**

The permittee is authorized to make changes within the Title V facility in accordance with the following provisions in 25 Pa. Code Chapter 127 which implement the operational flexibility requirements of Section 502(b)(10) of the Clean Air Act and Section 6.1(i) of the Air Pollution Control Act:

- (1) Section 127.14 (relating to exemptions)
- (2) Section 127.447 (relating to alternative operating scenarios)
- (3) Section 127.448 (relating to emissions trading at facilities with federally enforceable emissions caps)
- (4) Section 127.449 (relating to de minimis emission increases)
- (5) Section 127.450 (relating to administrative operating permit amendments)
- (6) Section 127.462 (relating to minor operating permit amendments)
- (7) Subchapter H (relating to general plan approvals and operating permits)

**#028 [25 Pa. Code §§ 127.441(d), 127.512(i) and 40 CFR Part 68]****Risk Management**

(a) If required by Section 112(r) of the Clean Air Act, the permittee shall develop and implement an accidental release program consistent with requirements of the Clean Air Act, 40 CFR Part 68 (relating to chemical accident prevention provisions) and the Federal Chemical Safety Information, Site Security and Fuels Regulatory Relief Act (P.L. 106-40).

(b) The permittee shall prepare and implement a Risk Management Plan (RMP) which meets the requirements of Section 112(r) of the Clean Air Act, 40 CFR Part 68 and the Federal Chemical Safety Information, Site Security and Fuels Regulatory Relief Act when a regulated substance listed in 40 CFR § 68.130 is present in a process in more than the listed threshold quantity at the Title V facility. The permittee shall submit the RMP to the federal Environmental Protection Agency according to the following schedule and requirements:

- (1) The permittee shall submit the first RMP to a central point specified by EPA no later than the latest of the following:
  - (i) Three years after the date on which a regulated substance is first listed under § 68.130; or,
  - (ii) The date on which a regulated substance is first present above a threshold quantity in a process.

(2) The permittee shall submit any additional relevant information requested by the Department or EPA concerning the RMP and shall make subsequent submissions of RMPs in accordance with 40 CFR § 68.190.

(3) The permittee shall certify that the RMP is accurate and complete in accordance with the requirements of 40 CFR Part 68, including a checklist addressing the required elements of a complete RMP.

(c) As used in this permit condition, the term "process" shall be as defined in 40 CFR § 68.3. The term "process" means any activity involving a regulated substance including any use, storage, manufacturing, handling, or on-site movement of such substances or any combination of these activities. For purposes of this definition, any group of vessels that are interconnected, or separate vessels that are located such that a regulated substance could be involved in a potential release, shall be considered a single process.

(d) If the Title V facility is subject to 40 CFR Part 68, as part of the certification required under this permit, the permittee shall:

- (1) Submit a compliance schedule for satisfying the requirements of 40 CFR Part 68 by the date specified in 40 CFR § 68.10(a); or,
- (2) Certify that the Title V facility is in compliance with all requirements of 40 CFR Part 68 including the registration and submission of the RMP.

**SECTION B. General Title V Requirements**

(e) If the Title V facility is subject to 40 CFR Part 68, the permittee shall maintain records supporting the implementation of an accidental release program for five (5) years in accordance with 40 CFR § 68.200.

(f) When the Title V facility is subject to the accidental release program requirements of Section 112(r) of the Clean Air Act and 40 CFR Part 68, appropriate enforcement action will be taken by the Department if:

(1) The permittee fails to register and submit the RMP or a revised plan pursuant to 40 CFR Part 68.

(2) The permittee fails to submit a compliance schedule or include a statement in the compliance certification required under Section B, Condition #026 of this permit that the Title V facility is in compliance with the requirements of Section 112(r) of the Clean Air Act, 40 CFR Part 68, and 25 Pa. Code § 127.512(i).

**#029 [25 Pa. Code § 127.512(e)]****Approved Economic Incentives and Emission Trading Programs**

No permit revision shall be required under approved economic incentives, marketable permits, emissions trading and other similar programs or processes for changes that are provided for in this Title V permit.

**#030 [25 Pa. Code §§ 127.516, 127.450(d), 127.449(f) & 127.462(g)]****Permit Shield**

(a) The permittee's compliance with the conditions of this permit shall be deemed in compliance with applicable requirements (as defined in 25 Pa. Code § 121.1) as of the date of permit issuance if either of the following applies:

(1) The applicable requirements are included and are specifically identified in this permit.

(2) The Department specifically identifies in the permit other requirements that are not applicable to the permitted facility or source.

(b) Nothing in 25 Pa. Code § 127.516 or the Title V permit shall alter or affect the following:

(1) The provisions of Section 303 of the Clean Air Act, including the authority of the Administrator of the EPA provided thereunder.

(2) The liability of the permittee for a violation of an applicable requirement prior to the time of permit issuance.

(3) The applicable requirements of the acid rain program, consistent with Section 408(a) of the Clean Air Act.

(4) The ability of the EPA to obtain information from the permittee under Section 114 of the Clean Air Act.

(c) Unless precluded by the Clean Air Act or regulations thereunder, final action by the Department incorporating a significant permit modification in this Title V Permit shall be covered by the permit shield at the time that the permit containing the significant modification is issued.

**#031 [25 Pa. Code §135.3]****Reporting**

(a) The permittee shall submit by March 1 of each year an annual emissions report for the preceding calendar year. The report shall include information for all active previously reported sources, new sources which were first operated during the preceding calendar year, and sources modified during the same period which were not previously reported. All air emissions from the facility should be estimated and reported.

(b) A source owner or operator may request an extension of time from the Department for the filing of an annual emissions report, and the Department may grant the extension for reasonable cause.

**#032 [25 Pa. Code §135.4]****Report Format**

Emissions reports shall contain sufficient information to enable the Department to complete its emission inventory. Emissions reports shall be made by the source owner or operator in a format specified by the Department.

**SECTION C. Site Level Requirements****I. RESTRICTIONS.****Emission Restriction(s).****# 001 [25 Pa. Code §123.1]****Prohibition of certain fugitive emissions**

(a) No person may permit the emission into the outdoor atmosphere of fugitive air contaminant from a source other than the following:

- (1) Construction or demolition of buildings or structures.
- (2) Grading, paving and maintenance of roads and streets.
- (3) Use of roads and streets. Emissions from material in or on trucks, railroad cars and other vehicular equipment are not considered as emissions from use of roads and streets.
- (4) Clearing of land.
- (5) Stockpiling of materials.
- (6) Open burning operations.
- (7) Blasting in open pit mines. Emissions from drilling are not considered as emissions from blasting.
- (8) N/A.

(9) Sources and classes of sources other than those identified in paragraphs (1)-(8), for which the operator has obtained a determination from the Department that fugitive emissions from the source, after appropriate control, meet the following requirements:

- (i) the emissions are of minor significance with respect to causing air pollution; and
- (ii) the emissions are not preventing or interfering with the attainment or maintenance of any ambient air quality standard.

**# 002 [25 Pa. Code §123.2]****Fugitive particulate matter**

A person may not permit fugitive particulate matter to be emitted into the outdoor atmosphere from a source specified in 123.1(a)(1) - (9) (relating to prohibition of certain fugitive emissions) if such emissions are visible at the point the emissions pass outside the person's property.

**# 003 [25 Pa. Code §123.31]****Limitations****MALODOR EMISSIONS**

A person may not permit the emission into the outdoor atmosphere of any malodorous air contaminants from any source in such a manner that the malodors are detectable outside the property of the person on whose land the source is being operated.

**# 004 [25 Pa. Code §123.41]****Limitations****VISIBLE EMISSIONS**

(a) A person may not permit the emission into the outdoor atmosphere of visible air contaminants in such a manner that the opacity of the emission is either of the following:

- (1) Equal to or greater than 20% for a period or periods aggregating more than three minutes in any 1 hour.
- (2) Equal to or greater than 60% at any time.

**# 005 [25 Pa. Code §123.42]****Exceptions**

(a) The limitations of SECTION C, Condition #004 shall not apply to a visible emission in any of the following instances:

- (1) When the presence of uncombined water is the only reason for failure of the emission to meet the limitations.
- (2) When the emission results from the operation of equipment used solely to train and test persons in observing the opacity of visible emissions.

**SECTION C. Site Level Requirements**

(3) When the emission results from sources specified in SECTION C, Condition #001.

**# 006 [25 Pa. Code §139.11]****General requirements.**

(a) The following are applicable to source tests for determining emissions from stationary sources:

(1) Performance tests shall be conducted while the source is operating at maximum routine operating conditions or under such other conditions, within the capacity of the equipment, as may be requested by the Department.

(2) The Department will consider for approval where sufficient information is provided to verify the source conditions existing at the time of the test and where adequate data is available to show the manner in which the test was conducted.

Information submitted to the Department shall include, as a minimum all of the following:

(i) A thorough source description, including a description of any air cleaning devices and the flue.

(ii) Process conditions, for example, the charging rate of raw material or rate of production of final product, boiler pressure, oven temperature, and other conditions which may affect emissions from the process.

(iii) The location of the sampling ports.

(iv) Effluent characteristics, including velocity, temperature, moisture content, gas density (percentage CO, CO<sub>2</sub>, O<sub>2</sub> and N<sub>2</sub>), static and barometric pressures.

(v) Sample collection techniques employed, including procedures used, equipment descriptions and data to verify that isokinetic sampling for particulate matter collection occurred and that acceptable test conditions were met.

(vi) Laboratory procedures and results.

(vii) Calculated results.

**II. TESTING REQUIREMENTS.****# 007 [25 Pa. Code §127.511]****Monitoring and related recordkeeping and reporting requirements.**

All sampling, testing and analyses performed in compliance with the requirements of any section of this permit shall be done in accordance with SECTION B - General Title V Requirements #023.

**# 008 [25 Pa. Code §139.1]****Sampling facilities.**

If requested by the Department, the permittee shall conduct performance (stack) tests in accordance with the provisions of Chapter 139 of the Rules and Regulations of the Department. The permittee will provide adequate sampling ports, safe sampling platforms, and adequate utilities for the performance by the Department of tests on such sources. The Department will set forth, in the request, the time period in which the facilities shall be provided as well as the specifications for such facilities.

**III. MONITORING REQUIREMENTS.****# 009 [25 Pa. Code §123.43]****Measuring techniques****VISIBLE EMISSIONS**

(a) Visible emissions may be measured using either of the following:

(1) A device approved by the Department and maintained to provide accurate opacity measurements.

(2) Observers, trained and qualified to measure plume opacity with the naked eye or with the aid of any devices approved by the Department.

**# 010 [25 Pa. Code §127.511]****Monitoring and related recordkeeping and reporting requirements.**

**SECTION C. Site Level Requirements****FUGITIVE, VISIBLE, AND MALODOR EMISSIONS**

(a) The permittee shall conduct weekly inspections around the plant periphery of the facility during daylight hours while the facility is operating to determine the presence of visible emissions, fugitive emissions, and malodors. Weekly inspections shall be conducted to determine:

- (1) The presence of visible emissions in excess of limits stated in SECTION C, Condition #004.
- (2) The presence of visible fugitive emissions beyond the boundaries of the facility.
- (3) The presence of malodors beyond the boundaries of the facility.

(b) All detected visible emissions, visible fugitive emissions, or malodors that have the potential to exceed applicable limits shall be reported to the manager of the facility.

(c) Visible emissions may be measured according to the methods specified in SECTION C, Condition #009, or alternatively, plant personnel who observe any visible emissions will report the incidents of visible emissions to the Department within four (4) hours of each incident and make arrangements for a certified observer to verify the opacity of the visible emission.

**IV. RECORDKEEPING REQUIREMENTS.****# 011 [25 Pa. Code §127.511]****Monitoring and related recordkeeping and reporting requirements.****FUGITIVE, VISIBLE, AND MALODOR EMISSIONS**

(a) The permittee shall keep a logbook of instances of visible emissions, visible fugitive emissions, and malodorous air emissions that deviate from the limitations in SECTION C, Conditions #002 and #004, the name of the company representative observing these instances, and the date and time of each occurrence.

(b) The permittee shall record any and all corrective actions taken to abate each recorded deviation or occurrences and future prevention.

(c) All records generated pursuant to this permit condition shall be retained for a minimum of five (5) years and shall be made available to the Department upon request

**# 012 [25 Pa. Code §127.511]****Monitoring and related recordkeeping and reporting requirements.**

All records, reports and analysis results generated in compliance with the requirements of any section of this permit shall be maintained in accordance with SECTION B - General Title V Requirements #024, and shall be made available to the Department upon written or verbal request at a reasonable time.

**V. REPORTING REQUIREMENTS.****# 013 [25 Pa. Code §127.511]****Monitoring and related recordkeeping and reporting requirements.****FUGITIVE, VISIBLE, AND MALODOR EMISSIONS**

(a) On a semi-annual basis, (by March 1 for period July 1 - December 31 and by September 1 for period January 1 - July 31), the permittee shall compile a report of all logged instances of deviation from the fugitive, visible, and malodor emission limitations that occurred and the actions taken in response to them. This report shall be submitted to the Department.

(b) If no deviations have been logged during the reported period, this report shall be retained at the facility and made available to the Department upon request.

**SECTION C. Site Level Requirements****# 014 [25 Pa. Code §127.511]****Monitoring and related recordkeeping and reporting requirements.**

(a) The permittee, within four (4) hours of discovery of an occurrence, shall notify the Department by phone at (610) 861-2070, of any malfunction, record keeping or reporting errors, or other possible non-compliance issues, which reasonably is believed to either result in or possibly result in, or which results in, the emission of air contaminants in excess of the limitations specified in, or established pursuant to, any applicable rule or regulations contained in Article III of the Rules and Regulations of the Department of Environmental Protection.

(b) A written report shall be submitted to the Department within five (5) working days following the initial notification describing the incident and the corrective actions taken or to be taken. The Department may take enforcement action for any violations of the applicable standards.

**# 015 [25 Pa. Code §127.513]****Compliance certification.**

The reporting period for the Certificate of Compliance required by SECTION B - Condition #026 shall be for the previous calendar year, and it shall be submitted within 60 days after the specified period but no later than March 1st.

**# 016 [25 Pa. Code §135.21]****Emission statements**

(a) The permittee shall provide the Department with a statement of each stationary source in a form as prescribed by the Department, showing the actual emissions of oxides of nitrogen and volatile organic compounds (VOCs) from the permitted facility for each reporting period, a description of the method used to calculate the emissions and the time period over which the calculation is based.

(b) The annual emission statements are due by March 1 for the preceding calendar year and shall contain a certification by a company officer or the plant manager that the information contained in the statement is accurate. The Emission Statement shall provide data consistent with requirements and guidance developed by the EPA.

(c) The Department may require more frequent submittals if the Department determines that one or more of the following applies:

- (1) A more frequent submission is required by the EPA.
- (2) Analysis of the data on a more frequent basis is necessary to implement the requirements of the Air Pollution Control Act.

**# 017 [25 Pa. Code §135.3]****Reporting**

(a) A person who owns or operates a source to which this permit applies, and who has previously been advised by the Department to submit a source (AIMS) report, shall submit by March 1 of each year a source report for the preceding calendar year. The report shall include information for all previously reported sources, new sources which were first operated during the preceding calendar year and sources modified during the same period which were not previously reported.

(b) A person who receives initial notification by the Department that a source report is necessary shall submit an initial source report within sixty (60) days after receiving the notification or by March 1 of the year following the year for which the report is required, whichever is later.

(c) A source owner or operator may request an extension of time from the Department for the filing of a source report, and the Department may grant the extension for reasonable cause.

**SECTION C. Site Level Requirements****VI. WORK PRACTICE REQUIREMENTS.****# 018 [25 Pa. Code §123.1]****Prohibition of certain fugitive emissions**

(a) A person responsible for any source specified in subsections (a)(1) - (9) shall take all reasonable actions to prevent particulate matter from becoming airborne. These actions shall include, but not be limited to, the following:

- (1) Use, where possible, of water or chemicals for control of dust in the demolition of buildings or structures, construction operations, the grading of roads, or the clearing of land.
- (2) Application of asphalt, oil, water or suitable chemicals on dirt roads, material stockpiles and other surfaces which may give rise to airborne dusts.
- (3) Paving and maintenance of roadways.
- (4) Prompt removal of earth or other material from paved streets onto which earth or other material has been transported by trucking or earth moving equipment, erosion by water, or other means.

**# 019 [25 Pa. Code §129.14]****Open burning operations**

(a) Outside of air basins. No person may permit the open burning of material in an area outside of air basins in a manner that:

- (1) The emissions are visible, at any time, at the point such emissions pass outside the property of the person on whose land the open burning is being conducted.
- (2) Malodorous air contaminants from the open burning are detectable outside the property of the person on whose land the open burning is being conducted.
- (3) The emissions interfere with the reasonable enjoyment of life or property.
- (4) The emissions cause damage to vegetation or property.
- (5) The emissions are or may be deleterious to human or animal health.

(b) Exceptions: The requirements of subsection (a) do not apply where the open burning operations result from:

- (1) A fire set to prevent or abate a fire hazard, when approved by the Department and set by or under the supervision of a public officer.
- (2) A fire set for the purpose of instructing personnel in firefighting, when approved by the Department.
- (3) A fire set for the prevention and control of disease or pests, when approved by the Department.
- (4) A fire set in conjunction with the production of agricultural commodities in their unmanufactured state on the premises of the farm operation.
- (5) A fire set for the purpose of burning domestic refuse, when the fire is on the premises of a structure occupied solely as a dwelling by two families or less and when the refuse results from the normal occupancy of such structure.
- (6) A fire set solely for recreational or ceremonial purposes.
- (7) A fire set solely for cooking food.

(c) Clearing and grubbing wastes. The following is applicable to clearing and grubbing wastes:

- (1) As used in this subsection the following terms shall have the following meanings:

Air curtain destructor -- A mechanical device which forcefully projects a curtain of air across a pit in which open burning is being conducted so that combustion efficiency is increased and smoke and other particulate matter are contained.

Clearing and grubbing wastes -- Trees, shrubs, and other native vegetation which are cleared from land during or prior to the process of construction. The term does not include demolition wastes and dirt laden roots.

(2) Subsection (a) notwithstanding clearing and grubbing wastes may be burned outside of an air basin, subject to the following limitations:

- (i) Upon receipt of a complaint or determination by the Department that an air pollution problem exists, the Department may order that the open burning cease or comply with subsection (b) of this section.
- (ii) Authorization for open burning under this paragraph does not apply to clearing and grubbing wastes transported from an air basin for disposal outside of an air basin.

- (3) During an air pollution episode, open burning is limited by Chapter 137 (relating to air pollution episodes) and shall

**SECTION C. Site Level Requirements**

cease as specified in such chapter.

**VII. ADDITIONAL REQUIREMENTS.**

**# 020 [25 Pa. Code §127.512]**  
**Operating permit terms and conditions.**

The BEFESA, Palmerton Facility is a major source for NOx emissions and is subject to RACT II requirements for NOx.

**VIII. COMPLIANCE CERTIFICATION.**

No additional compliance certifications exist except as provided in other sections of this permit including Section B (relating to Title V General Requirements).

**IX. COMPLIANCE SCHEDULE.**

No compliance milestones exist.

**\*\*\* Permit Shield In Effect \*\*\***



**SECTION D. Source Level Requirements**

Source ID: 101

Source Name: KILN #2 - ID FAN EMERGENCY DRIVE ENGINES

Source Capacity/Throughput: 5.100 MMBTU/HR

Conditions for this source occur in the following groups: GROUP 01

**I. RESTRICTIONS.**

No additional requirements exist except as provided in other sections of this permit including Section B (Title V General Requirements) and/or Section E (Source Group Restrictions).

**II. TESTING REQUIREMENTS.**

No additional testing requirements exist except as provided in other sections of this permit including Section B (Title V General Requirements) and/or Section E (Source Group Restrictions).

**III. MONITORING REQUIREMENTS.**

No additional monitoring requirements exist except as provided in other sections of this permit including Section B (Title V General Requirements) and/or Section E (Source Group Restrictions).

**IV. RECORDKEEPING REQUIREMENTS.**

No additional record keeping requirements exist except as provided in other sections of this permit including Section B (Title V General Requirements) and/or Section E (Source Group Restrictions).

**V. REPORTING REQUIREMENTS.**

No additional reporting requirements exist except as provided in other sections of this permit including Section B (Title V General Requirements) and/or Section E (Source Group Restrictions).

**VI. WORK PRACTICE REQUIREMENTS.**

No additional work practice requirements exist except as provided in other sections of this permit including Section B (Title V General Requirements) and/or Section E (Source Group Restrictions).

**VII. ADDITIONAL REQUIREMENTS.**

No additional requirements exist except as provided in other sections of this permit including Section B (Title V General Requirements) and/or Section E (Source Group Restrictions).

**\*\*\* Permit Shield in Effect. \*\*\***

**SECTION D. Source Level Requirements**

Source ID: 102

Source Name: KILN #5 - ID FAN EMERGENCY DRIVE ENGINES

Source Capacity/Throughput: 5.100 MMBTU/HR

Conditions for this source occur in the following groups: GROUP 01

**I. RESTRICTIONS.**

No additional requirements exist except as provided in other sections of this permit including Section B (Title V General Requirements) and/or Section E (Source Group Restrictions).

**II. TESTING REQUIREMENTS.**

No additional testing requirements exist except as provided in other sections of this permit including Section B (Title V General Requirements) and/or Section E (Source Group Restrictions).

**III. MONITORING REQUIREMENTS.**

No additional monitoring requirements exist except as provided in other sections of this permit including Section B (Title V General Requirements) and/or Section E (Source Group Restrictions).

**IV. RECORDKEEPING REQUIREMENTS.**

No additional record keeping requirements exist except as provided in other sections of this permit including Section B (Title V General Requirements) and/or Section E (Source Group Restrictions).

**V. REPORTING REQUIREMENTS.**

No additional reporting requirements exist except as provided in other sections of this permit including Section B (Title V General Requirements) and/or Section E (Source Group Restrictions).

**VI. WORK PRACTICE REQUIREMENTS.**

No additional work practice requirements exist except as provided in other sections of this permit including Section B (Title V General Requirements) and/or Section E (Source Group Restrictions).

**VII. ADDITIONAL REQUIREMENTS.**

No additional requirements exist except as provided in other sections of this permit including Section B (Title V General Requirements) and/or Section E (Source Group Restrictions).

**\*\*\* Permit Shield in Effect. \*\*\***

**SECTION D. Source Level Requirements**

Source ID: 103

Source Name: KILN #1 EMERGENCY GENERATOR (PLAN APPROVAL #13-308-104)

Source Capacity/Throughput: 12.000 MMBTU/HR

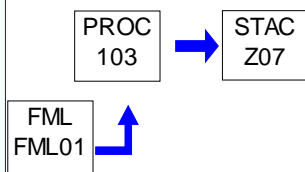
**I. RESTRICTIONS.****Emission Restriction(s).****# 001 [25 Pa. Code §123.13]****Processes**

(a) No person may permit the emission into the outdoor atmosphere of particulate matter from any process in a manner that the concentration of particulate matter in the effluent gas exceeds 0.04 grain per dry standard cubic foot, when the effluent gas volume is less than 150,000 dry standard cubic feet per minute.

**# 002 [25 Pa. Code §123.21]****General**

No person may permit the emission into the outdoor atmosphere of sulfur oxides from a source in a manner that the concentration of the sulfur oxides, expressed as SO<sub>2</sub>, in the effluent gas exceeds 500 parts per million, by volume, dry basis.

**# 003 [25 Pa. Code §127.512]****Operating permit terms and conditions.**

This source shall only utilize Low Sulfur #2 Fuel Oil that meets the requirements of 25 Pa. Code 123.22(a)(2).

This source shall not operate more than one hundred (100) hours per year.

**II. TESTING REQUIREMENTS.**

No additional testing requirements exist except as provided in other sections of this permit including Section B (Title V General Requirements).

**III. MONITORING REQUIREMENTS.****# 004 [25 Pa. Code §123.21]****General**

The company shall monitor sulfur content in the #2 fuel oil by certification from the fuel supplier for each shipment prior to any amount of fuel oil being used to assure compliance with emission restriction. Sulfur content in the fuel oil shall be limited to 15 ppm by weight.

**IV. RECORDKEEPING REQUIREMENTS.****# 005 [25 Pa. Code §127.512]****Operating permit terms and conditions.**

(a) The permittee shall, at a minimum, record and maintain records showing the fuel use and operating hours restriction.

**SECTION D. Source Level Requirements**

(b) In addition, records shall be maintained in accordance with 40 CFR 63 Subpart ZZZZ. These records shall be made available to the Department and maintained for a period of five (5) years.

**# 006 [25 Pa. Code §127.512]****Operating permit terms and conditions.**

The permittee shall, on an annual basis, compile a record of the hours of operation of the generator through the year sufficient to demonstrate compliance with the operation time limitation. The records shall be maintained on-site and made available to the Department upon request.

**# 007 [40 CFR Part 63 NESHAPS for Source Categories §40 CFR 63.6640]****Subpart ZZZZ - National Emissions Standards for Hazardous Air Pollutants for Stationary Reciprocating Internal Combustion Engines****How do I demonstrate continuous compliance with the emission limitations, operating limitations, and other requirements?**

- (a) Keep records of the hours of operation of the engine recorded through the non-resettable hour meter.
- (b) Document how many hours are spent for emergency operation, including what classified the operation as emergency, and how many hours are spent for non-emergency operation.
- (c) If the engine is operated during a period that has been declared an "Emergency Alert Level 2" by an authorized entity, the owner/operator must keep records of the notification of the emergency situation, and the date, start time, and end time of the engine operation for this purpose.
- (d) If the engine is operated when there is a deviation of voltage or frequency of 5% or greater below standard voltage or frequency, the owner/operator must keep records of the notification of the emergency situation, and the date, start time, and end time of the engine operation for this purpose.
- (e) Maintain records of the maintenance conducted on the RICE in order to demonstrate that the RICE is operated and maintained according to the maintenance instructions/plan.

**V. REPORTING REQUIREMENTS.**

No additional reporting requirements exist except as provided in other sections of this permit including Section B (Title V General Requirements).

**VI. WORK PRACTICE REQUIREMENTS.****# 008 [40 CFR Part 63 NESHAPS for Source Categories §40 CFR 63.6640]****Subpart ZZZZ - National Emissions Standards for Hazardous Air Pollutants for Stationary Reciprocating Internal Combustion Engines****How do I demonstrate continuous compliance with the emission limitations, operating limitations, and other requirements?**

- (a) If you own or operate an existing stationary RICE located an area source of HAP emissions, you must comply with the requirements in Table 2d to Subpart ZZZZ and the operating limitations in Table 2d to Subpart ZZZZ that apply, including the following work practice standards.
  - (1) Change oil and filter every 500 hours of operation or annually, whichever comes first.
  - (2) Inspect the air cleaner every 1,000 hours of operation or annually, whichever comes first, and replace as necessary.
  - (3) Inspect all hoses and belts every 500 hours of operation or annually, whichever comes first, and replace as necessary.
- (b) Demonstrate continuous compliance by:
  - (1) Operating and maintaining the RICE according to the manufacture's emission-related operation and maintenance instructions or
  - (2) Develop and follow your own maintenance plan which must provide to the extent practicable for the maintenance and

**SECTION D. Source Level Requirements**

operation of the engine in a manner consistent with good air pollution control practice for minimizing emissions.

**VII. ADDITIONAL REQUIREMENTS.**

No additional requirements exist except as provided in other sections of this permit including Section B (Title V General Requirements).

**\*\*\* Permit Shield in Effect. \*\*\***

**SECTION D. Source Level Requirements**

Source ID: 149

Source Name: KILN #1 - WAEZLING SYSTEM

Source Capacity/Throughput:

Conditions for this source occur in the following groups: GROUP 02  
 GROUP 05  
 GROUP 06  
 GROUP 07

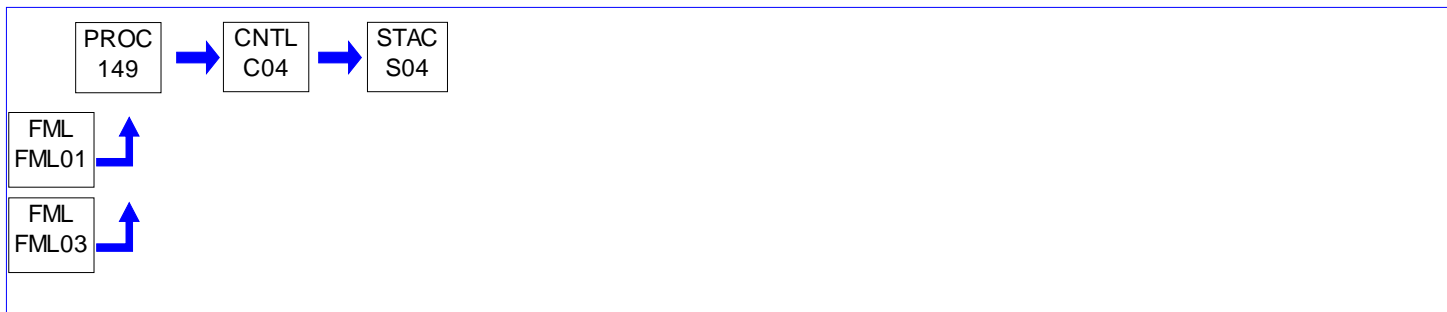
**I. RESTRICTIONS.****Emission Restriction(s).****# 001 [25 Pa. Code §127.512]****Operating permit terms and conditions.**

(a) Pursuant to the Best Available Technology (BAT) provision of 25 PA Code, Chapter 127.12, the facility is subject to the following air contaminant emission limitations and operating hours listed below:

Emission Limits (pounds per hour (lbs./hr.), and hours of operation (12-month rolling sum)

THE FOLLOWING EMISSION LIMITS WERE OBTAINED FROM PLAN APPROVAL #13-308-104 ISSUED FEBRUARY 27, 2004 AND PLAN APPROVAL #13-00001B ISSUED OCTOBER 22, 2020.

SOURCE ID #149

	PMPM10(1)	SOx	NOx	VOC	CO	LEAD	HRS./YR.
Waelzing Mode	1.31	0.55	8.20	2.00	24.21	0.01	7884

(1) Total Particulate shall be determined by summing filterable particulate (as measured by EPA Method 5) and condensable particulate (as measured by EPA Method 202 or an equivalent method). Total PM10 shall be determined by summing filterable PM10 (as measured by EPA Method 201, EPA Method 201A, or an equivalent method) and condensable-PM10 (as measured by EPA Method 202 or an equivalent method). The Department may approve the results of the combined Method 5/ 202 sampling in-lieu of measuring Total PM10 emissions to verify compliance with operating permit limitations.

**II. TESTING REQUIREMENTS.****# 002 [25 Pa. Code §127.512]****Operating permit terms and conditions.**

(a) The company shall perform stack tests annually to show compliance with the emission limitation for CO from Kiln #1.

(b) The stack tests shall be performed while the SOURCE ID 149 is operating at the maximum rated capacity and in the Waelzing Mode as stated in the Application for Plan Approval #13-308-104.

(c) At least two weeks prior to the test, the Department shall be informed of the date and time of the test.



## SECTION D. Source Level Requirements

(d) Within sixty (60) days of the completion of the test required by (a) of this SECTION, two (2) copies of the complete test report, including all operating conditions, shall be submitted to the Regional Air Quality Program Manager and shall meet all applicable requirements specified in the most current version of the Department's Source Testing Manual.

### III. MONITORING REQUIREMENTS.

No additional monitoring requirements exist except as provided in other sections of this permit including Section B (Title V General Requirements) and/or Section E (Source Group Restrictions).

### IV. RECORDKEEPING REQUIREMENTS.

No additional record keeping requirements exist except as provided in other sections of this permit including Section B (Title V General Requirements) and/or Section E (Source Group Restrictions).

### V. REPORTING REQUIREMENTS.

No additional reporting requirements exist except as provided in other sections of this permit including Section B (Title V General Requirements) and/or Section E (Source Group Restrictions).

### VI. WORK PRACTICE REQUIREMENTS.

No additional work practice requirements exist except as provided in other sections of this permit including Section B (Title V General Requirements) and/or Section E (Source Group Restrictions).

### VII. ADDITIONAL REQUIREMENTS.

No additional requirements exist except as provided in other sections of this permit including Section B (Title V General Requirements) and/or Section E (Source Group Restrictions).

**\*\*\* Permit Shield in Effect. \*\*\***

**SECTION D. Source Level Requirements**

Source ID: 150

Source Name: KILN #2 - WAEZLING SYSTEM

Source Capacity/Throughput:

Conditions for this source occur in the following groups: GROUP 02  
 GROUP 05  
 GROUP 06  
 GROUP 07

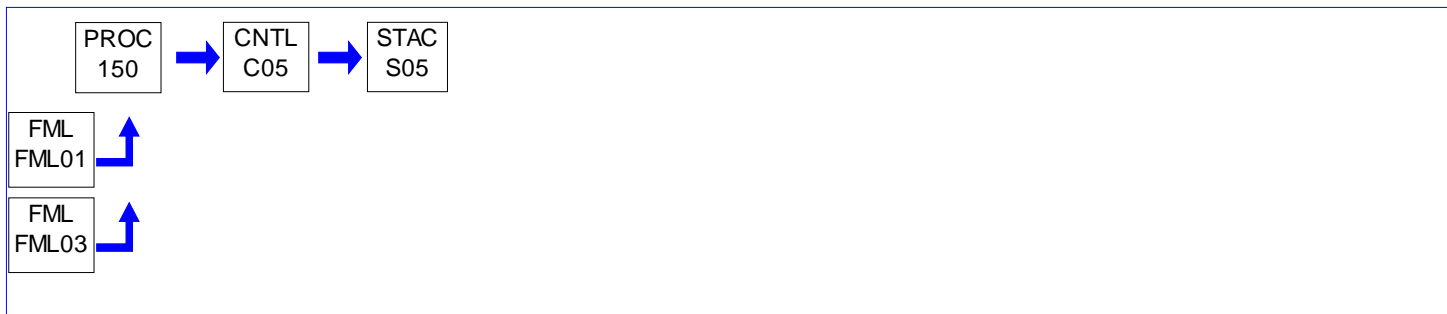
**I. RESTRICTIONS.****Emission Restriction(s).**

# 001 [25 Pa. Code §127.512]

**Operating permit terms and conditions.**

THE FOLLOWING EMISSION LIMITS WERE OBTAINED FROM RACT 1 OPERATING PERMIT #13-0001 ISSUED MAY 16, 1995 AND PLAN APPROVAL #13-00001B ISSUED OCTOBER 22, 2020.

(a) The Nitrogen Oxide (NO<sub>x</sub>) and Volatile Organic Compound (VOC) emission limit rates for this source are as follows:

- (1) The emission of NO<sub>x</sub> from Kiln #2 may not exceed 9.9 Pounds per Hour (lbs./hr.).
- (2) The emission of VOCs from Kiln #2 may not exceed 2.00 Pounds per Hour (lbs./hr.).

**II. TESTING REQUIREMENTS.**

No additional testing requirements exist except as provided in other sections of this permit including Section B (Title V General Requirements) and/or Section E (Source Group Restrictions).

**III. MONITORING REQUIREMENTS.**

No additional monitoring requirements exist except as provided in other sections of this permit including Section B (Title V General Requirements) and/or Section E (Source Group Restrictions).

**IV. RECORDKEEPING REQUIREMENTS.**

No additional record keeping requirements exist except as provided in other sections of this permit including Section B (Title V General Requirements) and/or Section E (Source Group Restrictions).

**V. REPORTING REQUIREMENTS.**

No additional reporting requirements exist except as provided in other sections of this permit including Section B (Title V General Requirements) and/or Section E (Source Group Restrictions).



**SECTION D. Source Level Requirements****VI. WORK PRACTICE REQUIREMENTS.**

No additional work practice requirements exist except as provided in other sections of this permit including Section B (Title V General Requirements) and/or Section E (Source Group Restrictions).

**VII. ADDITIONAL REQUIREMENTS.**

No additional requirements exist except as provided in other sections of this permit including Section B (Title V General Requirements) and/or Section E (Source Group Restrictions).

**\*\*\* Permit Shield in Effect. \*\*\***

**SECTION D. Source Level Requirements**

Source ID: 152

Source Name: KILN #5 - WAEZING SYSTEM

Source Capacity/Throughput:

Conditions for this source occur in the following groups: GROUP 02  
 GROUP 05  
 GROUP 06  
 GROUP 07

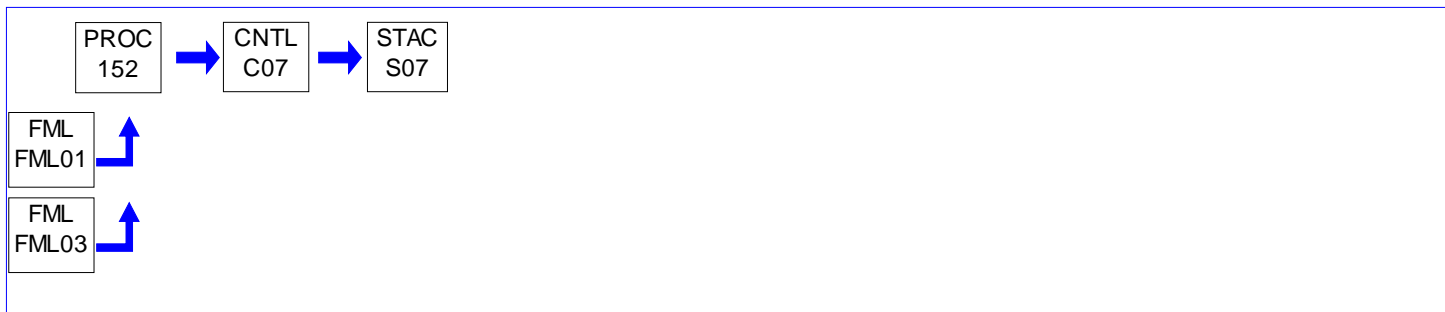
**I. RESTRICTIONS.****Emission Restriction(s).**

# 001 [25 Pa. Code §127.512]

**Operating permit terms and conditions.**

THE FOLLOWING EMISSION LIMITS WERE OBTAINED FROM RACT 1 OPERATING PERMIT #13-0001 ISSUED MAY 16, 1995 AND PLAN APPROVAL #13-00001B ISSUED OCTOBER 22, 2020.

(a) The Nitrogen Oxide (NO<sub>x</sub>) and Volatile Organic Compound (VOC) emission limit rates for this source are as follows:

- (1) The emission of NO<sub>x</sub> from Kiln #5 may not exceed 12.3 Pounds per Hour (lbs./hr.).
- (2) The emission of VOCs from Kiln #5 may not exceed 2.00 Pounds per Hour (lbs./hr.).

**II. TESTING REQUIREMENTS.**

No additional testing requirements exist except as provided in other sections of this permit including Section B (Title V General Requirements) and/or Section E (Source Group Restrictions).

**III. MONITORING REQUIREMENTS.**

No additional monitoring requirements exist except as provided in other sections of this permit including Section B (Title V General Requirements) and/or Section E (Source Group Restrictions).

**IV. RECORDKEEPING REQUIREMENTS.**

No additional record keeping requirements exist except as provided in other sections of this permit including Section B (Title V General Requirements) and/or Section E (Source Group Restrictions).

**V. REPORTING REQUIREMENTS.**

No additional reporting requirements exist except as provided in other sections of this permit including Section B (Title V General Requirements) and/or Section E (Source Group Restrictions).

**SECTION D. Source Level Requirements****VI. WORK PRACTICE REQUIREMENTS.**

No additional work practice requirements exist except as provided in other sections of this permit including Section B (Title V General Requirements) and/or Section E (Source Group Restrictions).

**VII. ADDITIONAL REQUIREMENTS.**

No additional requirements exist except as provided in other sections of this permit including Section B (Title V General Requirements) and/or Section E (Source Group Restrictions).

**\*\*\* Permit Shield in Effect. \*\*\***

**SECTION D. Source Level Requirements**

Source ID: 230

Source Name: CZO RECEIVING SILO

Source Capacity/Throughput:

Conditions for this source occur in the following groups: GROUP 04

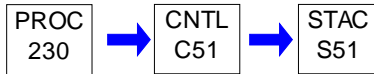
**I. RESTRICTIONS.**

No additional requirements exist except as provided in other sections of this permit including Section B (Title V General Requirements) and/or Section E (Source Group Restrictions).

**II. TESTING REQUIREMENTS.**

No additional testing requirements exist except as provided in other sections of this permit including Section B (Title V General Requirements) and/or Section E (Source Group Restrictions).

**III. MONITORING REQUIREMENTS.**

No additional monitoring requirements exist except as provided in other sections of this permit including Section B (Title V General Requirements) and/or Section E (Source Group Restrictions).

**IV. RECORDKEEPING REQUIREMENTS.**

No additional record keeping requirements exist except as provided in other sections of this permit including Section B (Title V General Requirements) and/or Section E (Source Group Restrictions).

**V. REPORTING REQUIREMENTS.**

No additional reporting requirements exist except as provided in other sections of this permit including Section B (Title V General Requirements) and/or Section E (Source Group Restrictions).

**VI. WORK PRACTICE REQUIREMENTS.**

No additional work practice requirements exist except as provided in other sections of this permit including Section B (Title V General Requirements) and/or Section E (Source Group Restrictions).

**VII. ADDITIONAL REQUIREMENTS.**

No additional requirements exist except as provided in other sections of this permit including Section B (Title V General Requirements) and/or Section E (Source Group Restrictions).

**\*\*\* Permit Shield in Effect. \*\*\***

**SECTION D. Source Level Requirements**

Source ID: 233

Source Name: EAF DUST FEED HOPPER LOADING - BUILDING 608

Source Capacity/Throughput:

Conditions for this source occur in the following groups: GROUP 04

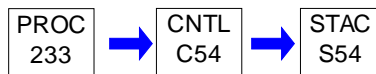
**I. RESTRICTIONS.**

No additional requirements exist except as provided in other sections of this permit including Section B (Title V General Requirements) and/or Section E (Source Group Restrictions).

**II. TESTING REQUIREMENTS.**

No additional testing requirements exist except as provided in other sections of this permit including Section B (Title V General Requirements) and/or Section E (Source Group Restrictions).

**III. MONITORING REQUIREMENTS.**

No additional monitoring requirements exist except as provided in other sections of this permit including Section B (Title V General Requirements) and/or Section E (Source Group Restrictions).

**IV. RECORDKEEPING REQUIREMENTS.**

No additional record keeping requirements exist except as provided in other sections of this permit including Section B (Title V General Requirements) and/or Section E (Source Group Restrictions).

**V. REPORTING REQUIREMENTS.**

No additional reporting requirements exist except as provided in other sections of this permit including Section B (Title V General Requirements) and/or Section E (Source Group Restrictions).

**VI. WORK PRACTICE REQUIREMENTS.**

No additional work practice requirements exist except as provided in other sections of this permit including Section B (Title V General Requirements) and/or Section E (Source Group Restrictions).

**VII. ADDITIONAL REQUIREMENTS.**

No additional requirements exist except as provided in other sections of this permit including Section B (Title V General Requirements) and/or Section E (Source Group Restrictions).

**\*\*\* Permit Shield in Effect. \*\*\***

**SECTION D. Source Level Requirements**

Source ID: 234

Source Name: EAF DUST TRESTLE CONVEYOR TRANSFER SYS.- BLD. 608

Source Capacity/Throughput:

Conditions for this source occur in the following groups: GROUP 04

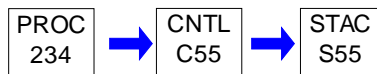
**I. RESTRICTIONS.**

No additional requirements exist except as provided in other sections of this permit including Section B (Title V General Requirements) and/or Section E (Source Group Restrictions).

**II. TESTING REQUIREMENTS.**

No additional testing requirements exist except as provided in other sections of this permit including Section B (Title V General Requirements) and/or Section E (Source Group Restrictions).

**III. MONITORING REQUIREMENTS.**

No additional monitoring requirements exist except as provided in other sections of this permit including Section B (Title V General Requirements) and/or Section E (Source Group Restrictions).

**IV. RECORDKEEPING REQUIREMENTS.**

No additional record keeping requirements exist except as provided in other sections of this permit including Section B (Title V General Requirements) and/or Section E (Source Group Restrictions).

**V. REPORTING REQUIREMENTS.**

No additional reporting requirements exist except as provided in other sections of this permit including Section B (Title V General Requirements) and/or Section E (Source Group Restrictions).

**VI. WORK PRACTICE REQUIREMENTS.**

No additional work practice requirements exist except as provided in other sections of this permit including Section B (Title V General Requirements) and/or Section E (Source Group Restrictions).

**VII. ADDITIONAL REQUIREMENTS.**

No additional requirements exist except as provided in other sections of this permit including Section B (Title V General Requirements) and/or Section E (Source Group Restrictions).

**\*\*\* Permit Shield in Effect. \*\*\***

**SECTION D. Source Level Requirements**

Source ID: 235A

Source Name: EAF DUST RAILCAR UNLOADING HOPPER

Source Capacity/Throughput:

Conditions for this source occur in the following groups: GROUP 04

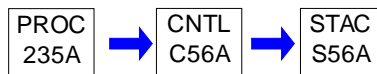
**I. RESTRICTIONS.**

No additional requirements exist except as provided in other sections of this permit including Section B (Title V General Requirements) and/or Section E (Source Group Restrictions).

**II. TESTING REQUIREMENTS.**

No additional testing requirements exist except as provided in other sections of this permit including Section B (Title V General Requirements) and/or Section E (Source Group Restrictions).

**III. MONITORING REQUIREMENTS.**

No additional monitoring requirements exist except as provided in other sections of this permit including Section B (Title V General Requirements) and/or Section E (Source Group Restrictions).

**IV. RECORDKEEPING REQUIREMENTS.**

No additional record keeping requirements exist except as provided in other sections of this permit including Section B (Title V General Requirements) and/or Section E (Source Group Restrictions).

**V. REPORTING REQUIREMENTS.**

No additional reporting requirements exist except as provided in other sections of this permit including Section B (Title V General Requirements) and/or Section E (Source Group Restrictions).

**VI. WORK PRACTICE REQUIREMENTS.**

No additional work practice requirements exist except as provided in other sections of this permit including Section B (Title V General Requirements) and/or Section E (Source Group Restrictions).

**VII. ADDITIONAL REQUIREMENTS.**

No additional requirements exist except as provided in other sections of this permit including Section B (Title V General Requirements) and/or Section E (Source Group Restrictions).

**\*\*\* Permit Shield in Effect. \*\*\***

**SECTION D. Source Level Requirements**

Source ID: 235B

Source Name: EAF DUST HOPPER CONVEYOR TRANSFER

Source Capacity/Throughput:

Conditions for this source occur in the following groups: GROUP 04

**I. RESTRICTIONS.**

No additional requirements exist except as provided in other sections of this permit including Section B (Title V General Requirements) and/or Section E (Source Group Restrictions).

**II. TESTING REQUIREMENTS.**

No additional testing requirements exist except as provided in other sections of this permit including Section B (Title V General Requirements) and/or Section E (Source Group Restrictions).

**III. MONITORING REQUIREMENTS.**

No additional monitoring requirements exist except as provided in other sections of this permit including Section B (Title V General Requirements) and/or Section E (Source Group Restrictions).

**IV. RECORDKEEPING REQUIREMENTS.**

No additional record keeping requirements exist except as provided in other sections of this permit including Section B (Title V General Requirements) and/or Section E (Source Group Restrictions).

**V. REPORTING REQUIREMENTS.**

No additional reporting requirements exist except as provided in other sections of this permit including Section B (Title V General Requirements) and/or Section E (Source Group Restrictions).

**VI. WORK PRACTICE REQUIREMENTS.**

No additional work practice requirements exist except as provided in other sections of this permit including Section B (Title V General Requirements) and/or Section E (Source Group Restrictions).

**VII. ADDITIONAL REQUIREMENTS.**

No additional requirements exist except as provided in other sections of this permit including Section B (Title V General Requirements) and/or Section E (Source Group Restrictions).

**\*\*\* Permit Shield in Effect. \*\*\***



**SECTION D. Source Level Requirements**

Source ID: 236

Source Name: EAF DUST PELLETIZER MATERIAL CONVEYOR TRANSFER - BLDG 608

Source Capacity/Throughput:

Conditions for this source occur in the following groups: GROUP 04

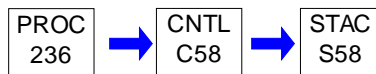
**I. RESTRICTIONS.**

No additional requirements exist except as provided in other sections of this permit including Section B (Title V General Requirements) and/or Section E (Source Group Restrictions).

**II. TESTING REQUIREMENTS.**

No additional testing requirements exist except as provided in other sections of this permit including Section B (Title V General Requirements) and/or Section E (Source Group Restrictions).

**III. MONITORING REQUIREMENTS.**

No additional monitoring requirements exist except as provided in other sections of this permit including Section B (Title V General Requirements) and/or Section E (Source Group Restrictions).

**IV. RECORDKEEPING REQUIREMENTS.**

No additional record keeping requirements exist except as provided in other sections of this permit including Section B (Title V General Requirements) and/or Section E (Source Group Restrictions).

**V. REPORTING REQUIREMENTS.**

No additional reporting requirements exist except as provided in other sections of this permit including Section B (Title V General Requirements) and/or Section E (Source Group Restrictions).

**VI. WORK PRACTICE REQUIREMENTS.**

No additional work practice requirements exist except as provided in other sections of this permit including Section B (Title V General Requirements) and/or Section E (Source Group Restrictions).

**VII. ADDITIONAL REQUIREMENTS.**

No additional requirements exist except as provided in other sections of this permit including Section B (Title V General Requirements) and/or Section E (Source Group Restrictions).

**\*\*\* Permit Shield in Effect. \*\*\***

**SECTION D. Source Level Requirements**

Source ID: 237

Source Name: CZO LOADING SPOUT

Source Capacity/Throughput:

Conditions for this source occur in the following groups: GROUP 04

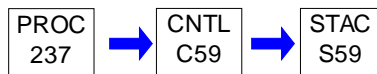
**I. RESTRICTIONS.**

No additional requirements exist except as provided in other sections of this permit including Section B (Title V General Requirements) and/or Section E (Source Group Restrictions).

**II. TESTING REQUIREMENTS.**

No additional testing requirements exist except as provided in other sections of this permit including Section B (Title V General Requirements) and/or Section E (Source Group Restrictions).

**III. MONITORING REQUIREMENTS.**

No additional monitoring requirements exist except as provided in other sections of this permit including Section B (Title V General Requirements) and/or Section E (Source Group Restrictions).

**IV. RECORDKEEPING REQUIREMENTS.**

No additional record keeping requirements exist except as provided in other sections of this permit including Section B (Title V General Requirements) and/or Section E (Source Group Restrictions).

**V. REPORTING REQUIREMENTS.**

No additional reporting requirements exist except as provided in other sections of this permit including Section B (Title V General Requirements) and/or Section E (Source Group Restrictions).

**VI. WORK PRACTICE REQUIREMENTS.**

No additional work practice requirements exist except as provided in other sections of this permit including Section B (Title V General Requirements) and/or Section E (Source Group Restrictions).

**VII. ADDITIONAL REQUIREMENTS.**

No additional requirements exist except as provided in other sections of this permit including Section B (Title V General Requirements) and/or Section E (Source Group Restrictions).

**\*\*\* Permit Shield in Effect. \*\*\***

**SECTION D. Source Level Requirements**

Source ID: 238

Source Name: F2 KILN DISCHARGE AREA FUGITIVE DUST - KILN #5

Source Capacity/Throughput:

Conditions for this source occur in the following groups: GROUP 03  
GROUP 05

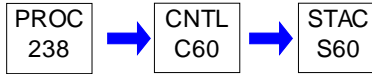
**I. RESTRICTIONS.**

No additional requirements exist except as provided in other sections of this permit including Section B (Title V General Requirements) and/or Section E (Source Group Restrictions).

**II. TESTING REQUIREMENTS.**

No additional testing requirements exist except as provided in other sections of this permit including Section B (Title V General Requirements) and/or Section E (Source Group Restrictions).

**III. MONITORING REQUIREMENTS.**

No additional monitoring requirements exist except as provided in other sections of this permit including Section B (Title V General Requirements) and/or Section E (Source Group Restrictions).

**IV. RECORDKEEPING REQUIREMENTS.**

No additional record keeping requirements exist except as provided in other sections of this permit including Section B (Title V General Requirements) and/or Section E (Source Group Restrictions).

**V. REPORTING REQUIREMENTS.**

No additional reporting requirements exist except as provided in other sections of this permit including Section B (Title V General Requirements) and/or Section E (Source Group Restrictions).

**VI. WORK PRACTICE REQUIREMENTS.**

No additional work practice requirements exist except as provided in other sections of this permit including Section B (Title V General Requirements) and/or Section E (Source Group Restrictions).

**VII. ADDITIONAL REQUIREMENTS.**

No additional requirements exist except as provided in other sections of this permit including Section B (Title V General Requirements) and/or Section E (Source Group Restrictions).

**\*\*\* Permit Shield in Effect. \*\*\***

**SECTION D. Source Level Requirements**

Source ID: 239

Source Name: F1 KILN DISCHARGE AREA FUGITIVE DUST - KILN #1 AND #2

Source Capacity/Throughput:

Conditions for this source occur in the following groups: GROUP 03

GROUP 05

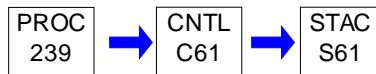
**I. RESTRICTIONS.**

No additional requirements exist except as provided in other sections of this permit including Section B (Title V General Requirements) and/or Section E (Source Group Restrictions).

**II. TESTING REQUIREMENTS.**

No additional testing requirements exist except as provided in other sections of this permit including Section B (Title V General Requirements) and/or Section E (Source Group Restrictions).

**III. MONITORING REQUIREMENTS.**

No additional monitoring requirements exist except as provided in other sections of this permit including Section B (Title V General Requirements) and/or Section E (Source Group Restrictions).

**IV. RECORDKEEPING REQUIREMENTS.**

No additional record keeping requirements exist except as provided in other sections of this permit including Section B (Title V General Requirements) and/or Section E (Source Group Restrictions).

**V. REPORTING REQUIREMENTS.**

No additional reporting requirements exist except as provided in other sections of this permit including Section B (Title V General Requirements) and/or Section E (Source Group Restrictions).

**VI. WORK PRACTICE REQUIREMENTS.**

No additional work practice requirements exist except as provided in other sections of this permit including Section B (Title V General Requirements) and/or Section E (Source Group Restrictions).

**VII. ADDITIONAL REQUIREMENTS.**

No additional requirements exist except as provided in other sections of this permit including Section B (Title V General Requirements) and/or Section E (Source Group Restrictions).

**\*\*\* Permit Shield in Effect. \*\*\***

**SECTION D. Source Level Requirements**

Source ID: 242

Source Name: MATERIAL STOCKPILES WIND EROSION - FUGITIVE DUSTS

Source Capacity/Throughput:

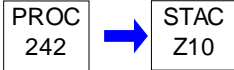
**I. RESTRICTIONS.**

No additional requirements exist except as provided in other sections of this permit including Section B (Title V General Requirements).

**II. TESTING REQUIREMENTS.**

No additional testing requirements exist except as provided in other sections of this permit including Section B (Title V General Requirements).

**III. MONITORING REQUIREMENTS.**

No additional monitoring requirements exist except as provided in other sections of this permit including Section B (Title V General Requirements).

**IV. RECORDKEEPING REQUIREMENTS.**

No additional record keeping requirements exist except as provided in other sections of this permit including Section B (Title V General Requirements).

**V. REPORTING REQUIREMENTS.**

No additional reporting requirements exist except as provided in other sections of this permit including Section B (Title V General Requirements).

**VI. WORK PRACTICE REQUIREMENTS.**

**# 001 [25 Pa. Code §127.512]**  
**Operating permit terms and conditions.**

The permittee shall comply with the requirements of the current Fugitive Dust Control Plan.

**VII. ADDITIONAL REQUIREMENTS.**

No additional requirements exist except as provided in other sections of this permit including Section B (Title V General Requirements).

**\*\*\* Permit Shield in Effect. \*\*\***

**SECTION D. Source Level Requirements**

Source ID: 244

Source Name: ROADWAY USAGE - FUGITIVE DUSTS

Source Capacity/Throughput:

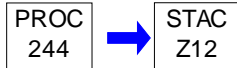
**I. RESTRICTIONS.**

No additional requirements exist except as provided in other sections of this permit including Section B (Title V General Requirements).

**II. TESTING REQUIREMENTS.**

No additional testing requirements exist except as provided in other sections of this permit including Section B (Title V General Requirements).

**III. MONITORING REQUIREMENTS.**

No additional monitoring requirements exist except as provided in other sections of this permit including Section B (Title V General Requirements).

**IV. RECORDKEEPING REQUIREMENTS.**

No additional record keeping requirements exist except as provided in other sections of this permit including Section B (Title V General Requirements).

**V. REPORTING REQUIREMENTS.**

No additional reporting requirements exist except as provided in other sections of this permit including Section B (Title V General Requirements).

**VI. WORK PRACTICE REQUIREMENTS.**

**# 001 [25 Pa. Code §127.512]**  
**Operating permit terms and conditions.**

The permittee shall comply with the requirements of the current Fugitive Dust Control Plan.

**VII. ADDITIONAL REQUIREMENTS.**

No additional requirements exist except as provided in other sections of this permit including Section B (Title V General Requirements).

**\*\*\* Permit Shield in Effect. \*\*\***

**SECTION D. Source Level Requirements**

Source ID: 245

Source Name: KILN FEED BINS

Source Capacity/Throughput:

Conditions for this source occur in the following groups: GROUP 04

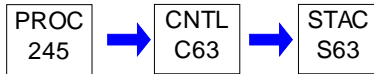
**I. RESTRICTIONS.**

No additional requirements exist except as provided in other sections of this permit including Section B (Title V General Requirements) and/or Section E (Source Group Restrictions).

**II. TESTING REQUIREMENTS.**

No additional testing requirements exist except as provided in other sections of this permit including Section B (Title V General Requirements) and/or Section E (Source Group Restrictions).

**III. MONITORING REQUIREMENTS.**

No additional monitoring requirements exist except as provided in other sections of this permit including Section B (Title V General Requirements) and/or Section E (Source Group Restrictions).

**IV. RECORDKEEPING REQUIREMENTS.**

No additional record keeping requirements exist except as provided in other sections of this permit including Section B (Title V General Requirements) and/or Section E (Source Group Restrictions).

**V. REPORTING REQUIREMENTS.**

No additional reporting requirements exist except as provided in other sections of this permit including Section B (Title V General Requirements) and/or Section E (Source Group Restrictions).

**VI. WORK PRACTICE REQUIREMENTS.**

No additional work practice requirements exist except as provided in other sections of this permit including Section B (Title V General Requirements) and/or Section E (Source Group Restrictions).

**VII. ADDITIONAL REQUIREMENTS.**

No additional requirements exist except as provided in other sections of this permit including Section B (Title V General Requirements) and/or Section E (Source Group Restrictions).

**\*\*\* Permit Shield in Effect. \*\*\***

**SECTION D. Source Level Requirements**

Source ID: 246

Source Name: EAF DUST TRESTLE SILOS

Source Capacity/Throughput:

Conditions for this source occur in the following groups: GROUP 04

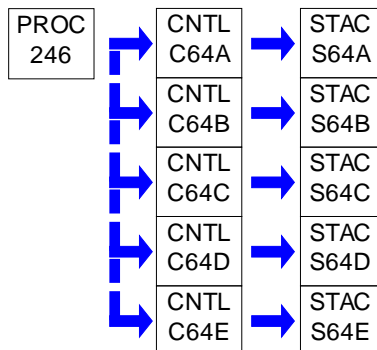
**I. RESTRICTIONS.**

No additional requirements exist except as provided in other sections of this permit including Section B (Title V General Requirements) and/or Section E (Source Group Restrictions).

**II. TESTING REQUIREMENTS.**

No additional testing requirements exist except as provided in other sections of this permit including Section B (Title V General Requirements) and/or Section E (Source Group Restrictions).

**III. MONITORING REQUIREMENTS.**

No additional monitoring requirements exist except as provided in other sections of this permit including Section B (Title V General Requirements) and/or Section E (Source Group Restrictions).

**IV. RECORDKEEPING REQUIREMENTS.**

No additional record keeping requirements exist except as provided in other sections of this permit including Section B (Title V General Requirements) and/or Section E (Source Group Restrictions).

**V. REPORTING REQUIREMENTS.**

No additional reporting requirements exist except as provided in other sections of this permit including Section B (Title V General Requirements) and/or Section E (Source Group Restrictions).

**VI. WORK PRACTICE REQUIREMENTS.**

No additional work practice requirements exist except as provided in other sections of this permit including Section B (Title V General Requirements) and/or Section E (Source Group Restrictions).

**VII. ADDITIONAL REQUIREMENTS.**

No additional requirements exist except as provided in other sections of this permit including Section B (Title V General Requirements) and/or Section E (Source Group Restrictions).

**\*\*\* Permit Shield in Effect. \*\*\***



**SECTION D. Source Level Requirements**

Source ID: 248CTR Source Name: CENTER CZO RECEIVING BIN

Source Capacity/Throughput:

Conditions for this source occur in the following groups: GROUP 04

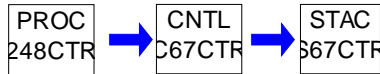
**I. RESTRICTIONS.****Emission Restriction(s).****# 001 [25 Pa. Code §127.512]  
Operating permit terms and conditions.**

(a) Pursuant to the Best Available Technology (BAT) provisions of Sections 127.1 and 127.12 of Chapter 127 of Article III of the Rules and Regulations of the Department of Environmental Protection, particulate matter emissions from the CZO receiving bin shall not exceed 0.02 grains per dscf during any time of operation.

(b) Additionally, annual particulate matter emissions from the receiving bin shall not exceed 1.31 tons

**II. TESTING REQUIREMENTS.****# 002 [25 Pa. Code §127.512]  
Operating permit terms and conditions.**

The pressure differential across the vent bin collectors shall be measured daily utilizing a differential manometer or equivalent.

**III. MONITORING REQUIREMENTS.**

No additional monitoring requirements exist except as provided in other sections of this permit including Section B (Title V General Requirements) and/or Section E (Source Group Restrictions).

**IV. RECORDKEEPING REQUIREMENTS.****# 003 [25 Pa. Code §127.512]  
Operating permit terms and conditions.**

(a) The permittee shall maintain records of the daily pressure differential across the vent bin collectors.

(b) The PM emissions shall be calculated and recorded to demonstrate compliance with the 1.31 tons limit.

(c) These records shall be kept for a period of five (5) years and made available to the Department upon request.

**V. REPORTING REQUIREMENTS.**

No additional reporting requirements exist except as provided in other sections of this permit including Section B (Title V General Requirements) and/or Section E (Source Group Restrictions).

**VI. WORK PRACTICE REQUIREMENTS.****# 004 [25 Pa. Code §127.512]  
Operating permit terms and conditions.**

(a) The permittee shall keep on hand a sufficient quantity of spare fabric collector bags/filters for the fabric collectors

**SECTION D. Source Level Requirements**

associated with this source in order to be able to immediately replace any bags/filters requiring replacement due to deterioration resulting from routine operation of the source and baghouse.

(b) The permittee shall maintain and operate the air pollution control equipment and sources in accordance with good engineering practices.

**# 005 [25 Pa. Code §127.512]**

**Operating permit terms and conditions.**

The receiving bin shall not be loaded without the simultaneous operation of the bin vent collectors

**# 006 [25 Pa. Code §127.512]**

**Operating permit terms and conditions.**

Pursuant to the Best Available Technology (BAT) provisions of Sections 127.1 and 127.12 of Chapter 127 of Article III of the Rules and Regulations of the Department of Environmental Protection, at no time shall tanker trucks and railcars be unloaded into the calcine kiln receiving bin simultaneously.

**VII. ADDITIONAL REQUIREMENTS.**

**# 007 [25 Pa. Code §127.512]**

**Operating permit terms and conditions.**

(a) If at any time the Department has cause to believe that air contaminant emissions from the aforementioned source may be in excess of the limitations specified in, or established pursuant to, any applicable rule or regulation contained in Article III of the Rules and Regulations of the Department of Environmental Protection, the company shall be required to conduct whatever tests are deemed necessary by the Department to determine the actual emission rates.

(b) Such testing shall be conducted in accordance with the revisions of Chapter 139 of the Rules and Regulations of the Department of Environmental Protection, where applicable, and in accordance with any restrictions or limitations established by the Department at such time it notifies the company that testing is required.

**# 008 [25 Pa. Code §127.512]**

**Operating permit terms and conditions.**

The company shall not impose conditions upon or otherwise restrict the Department's access to the aforementioned sources and/or any associated air cleaning devices and shall allow the Department to have access at any time to said sources and associated air cleaning device(s) with such measuring and recording equipment, including equipment recording visual observations, as the Department deems necessary and proper for performing its duties and for the effective enforcement of the Air Pollution Control Act.

**\*\*\* Permit Shield in Effect. \*\*\***

**SECTION D. Source Level Requirements**

Source ID: 248NTH Source Name: NORTH CZO RECEIVING BIN

Source Capacity/Throughput:

Conditions for this source occur in the following groups: GROUP 04

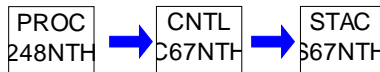
**I. RESTRICTIONS.****Emission Restriction(s).****# 001 [25 Pa. Code §127.512]  
Operating permit terms and conditions.**

(a) Pursuant to the Best Available Technology (BAT) provisions of Sections 127.1 and 127.12 of Chapter 127 of Article III of the Rules and Regulations of the Department of Environmental Protection, particulate matter emissions from the CZO receiving bin shall not exceed 0.02 grains per dscf during any time of operation.

(b) Additionally, annual particulate matter emissions from the receiving bin shall not exceed 1.31 tons

**II. TESTING REQUIREMENTS.**

No additional testing requirements exist except as provided in other sections of this permit including Section B (Title V General Requirements) and/or Section E (Source Group Restrictions).

**III. MONITORING REQUIREMENTS.****# 002 [25 Pa. Code §127.512]  
Operating permit terms and conditions.**

The pressure differential across the vent bin collectors shall be measured daily utilizing a differential manometer or equivalent.

**IV. RECORDKEEPING REQUIREMENTS.****# 003 [25 Pa. Code §127.512]  
Operating permit terms and conditions.**

(a) The permittee shall maintain records of the daily pressure differential across the vent bin collectors.

(b) The PM emissions shall be calculated and recorded to demonstrate compliance with the 1.31 tons limit.

(c) These records shall be kept for a period of five (5) years and made available to the Department upon request

**V. REPORTING REQUIREMENTS.**

No additional reporting requirements exist except as provided in other sections of this permit including Section B (Title V General Requirements) and/or Section E (Source Group Restrictions).

**VI. WORK PRACTICE REQUIREMENTS.****# 004 [25 Pa. Code §127.512]  
Operating permit terms and conditions.**

(a) The permittee shall keep on hand a sufficient quantity of spare fabric collector bags/filters for the fabric collectors

**SECTION D. Source Level Requirements**

associated with this source in order to be able to immediately replace any bags/filters requiring replacement due to deterioration resulting from routine operation of the source and baghouse.

(b) The permittee shall maintain and operate the air pollution control equipment and sources in accordance with good engineering practices

**# 005 [25 Pa. Code §127.512]**

**Operating permit terms and conditions.**

The receiving bin shall not be loaded without the simultaneous operation of the bin vent collectors

**# 006 [25 Pa. Code §127.512]**

**Operating permit terms and conditions.**

Pursuant to the Best Available Technology (BAT) provisions of Sections 127.1 and 127.12 of Chapter 127 of Article III of the Rules and Regulations of the Department of Environmental Protection, at no time shall tanker trucks and railcars be unloaded into the calcine kiln receiving bin simultaneously.

**VII. ADDITIONAL REQUIREMENTS.**

**# 007 [25 Pa. Code §127.512]**

**Operating permit terms and conditions.**

(a) If at any time the Department has cause to believe that air contaminant emissions from the aforementioned source may be in excess of the limitations specified in, or established pursuant to, any applicable rule or regulation contained in Article III of the Rules and Regulations of the Department of Environmental Protection, the company shall be required to conduct whatever tests are deemed necessary by the Department to determine the actual emission rates.

(b) Such testing shall be conducted in accordance with the revisions of Chapter 139 of the Rules and Regulations of the Department of Environmental Protection, where applicable, and in accordance with any restrictions or limitations established by the Department at such time it notifies the company that testing is required.

**# 008 [25 Pa. Code §127.512]**

**Operating permit terms and conditions.**

The company shall not impose conditions upon or otherwise restrict the Department's access to the aforementioned sources and/or any associated air cleaning devices and shall allow the Department to have access at any time to said sources and associated air cleaning device(s) with such measuring and recording equipment, including equipment recording visual observations, as the Department deems necessary and proper for performing its duties and for the effective enforcement of the Air Pollution Control Act.

**\*\*\* Permit Shield in Effect. \*\*\***

**SECTION D. Source Level Requirements**

Source ID: 248STH Source Name: SOUTH CZO RECEIVING BIN

Source Capacity/Throughput:

Conditions for this source occur in the following groups: GROUP 04

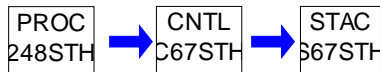
**I. RESTRICTIONS.****Emission Restriction(s).****# 001 [25 Pa. Code §127.512]  
Operating permit terms and conditions.**

(a) Pursuant to the Best Available Technology (BAT) provisions of Sections 127.1 and 127.12 of Chapter 127 of Article III of the Rules and Regulations of the Department of Environmental Protection, particulate matter emissions from the CZO receiving bin shall not exceed 0.02 grains per dscf during any time of operation.

(b) Additionally, annual particulate matter emissions from the receiving bin shall not exceed 1.31 tons

**II. TESTING REQUIREMENTS.**

No additional testing requirements exist except as provided in other sections of this permit including Section B (Title V General Requirements) and/or Section E (Source Group Restrictions).

**III. MONITORING REQUIREMENTS.****# 002 [25 Pa. Code §127.512]  
Operating permit terms and conditions.**

The pressure differential across the vent bin collectors shall be measured daily utilizing a differential manometer or equivalent.

**IV. RECORDKEEPING REQUIREMENTS.****# 003 [25 Pa. Code §127.512]  
Operating permit terms and conditions.**

(a) The permittee shall maintain records of the daily pressure differential across the vent bin collectors.

(b) The PM emissions shall be calculated and recorded to demonstrate compliance with the 1.31 tons limit.

(c) These records shall be kept for a period of five (5) years and made available to the Department upon request.

**V. REPORTING REQUIREMENTS.**

No additional reporting requirements exist except as provided in other sections of this permit including Section B (Title V General Requirements) and/or Section E (Source Group Restrictions).

**VI. WORK PRACTICE REQUIREMENTS.****# 004 [25 Pa. Code §127.512]  
Operating permit terms and conditions.**

(a) The permittee shall keep on hand a sufficient quantity of spare fabric collector bags/filters for the fabric collectors

**SECTION D. Source Level Requirements**

associated with this source in order to be able to immediately replace any bags/filters requiring replacement due to deterioration resulting from routine operation of the source and baghouse.

(b) The permittee shall maintain and operate the air pollution control equipment and sources in accordance with good engineering practices.

**# 005 [25 Pa. Code §127.512]**

**Operating permit terms and conditions.**

The receiving bin shall not be loaded without the simultaneous operation of the bin vent collectors.

**# 006 [25 Pa. Code §127.512]**

**Operating permit terms and conditions.**

Pursuant to the Best Available Technology (BAT) provisions of Sections 127.1 and 127.12 of Chapter 127 of Article III of the Rules and Regulations of the Department of Environmental Protection, at no time shall tanker trucks and railcars be unloaded into the calcine kiln receiving bin simultaneously.

**VII. ADDITIONAL REQUIREMENTS.**

**# 007 [25 Pa. Code §127.512]**

**Operating permit terms and conditions.**

(a) If at any time the Department has cause to believe that air contaminant emissions from the aforementioned source may be in excess of the limitations specified in, or established pursuant to, any applicable rule or regulation contained in Article III of the Rules and Regulations of the Department of Environmental Protection, the company shall be required to conduct whatever tests are deemed necessary by the Department to determine the actual emission rates.

(b) Such testing shall be conducted in accordance with the revisions of Chapter 139 of the Rules and Regulations of the Department of Environmental Protection, where applicable, and in accordance with any restrictions or limitations established by the Department at such time it notifies the company that testing is required.

**# 008 [25 Pa. Code §127.512]**

**Operating permit terms and conditions.**

The company shall not impose conditions upon or otherwise restrict the Department's access to the aforementioned sources and/or any associated air cleaning devices and shall allow the Department to have access at any time to said sources and associated air cleaning device(s) with such measuring and recording equipment, including equipment recording visual observations, as the Department deems necessary and proper for performing its duties and for the effective enforcement of the Air Pollution Control Act.

**\*\*\* Permit Shield in Effect. \*\*\***

**SECTION E. Source Group Restrictions.**

Group Name: GROUP 01

Group Description: EMERGENCY DRIVE ENGINES

Sources included in this group

ID	Name
101	KILN #2 - ID FAN EMERGENCY DRIVE ENGINES
102	KILN #5 - ID FAN EMERGENCY DRIVE ENGINES

**I. RESTRICTIONS.****Emission Restriction(s).****# 001 [25 Pa. Code §123.13]****Processes**

The concentration of particulate matter (expressed as TSP) in the emissions from each of these sources may not exceed 0.04 Grains per Dry Standard Cubic Foot of Total Suspended Particulate.

**# 002 [25 Pa. Code §123.21]****General**

The concentration of the sulfur oxides, expressed as SO<sub>2</sub>, in the emissions from each source may not exceed 500 parts per million by volume dry basis.

**# 003 [25 Pa. Code §127.512]****Operating permit terms and conditions.**

These sources shall only utilize natural gas, AP-42, or other relevant emission factors acceptable to the Department may be used to calculate emissions.

**II. TESTING REQUIREMENTS.**

No additional testing requirements exist except as provided in other sections of this permit including Section B (Title V General Requirements).

**III. MONITORING REQUIREMENTS.**

No additional monitoring requirements exist except as provided in other sections of this permit including Section B (Title V General Requirements).

**IV. RECORDKEEPING REQUIREMENTS.****# 004 [40 CFR Part 63 NESHAPS for Source Categories §40 CFR 63.6655]****Subpart ZZZZ - National Emissions Standards for Hazardous Air Pollutants for Stationary Reciprocating Internal Combustion Engines****What records must I keep?**

- (a) Keep records of the hours of operation of the engines recorded through the non-resettable hour meter.
- (b) Document how many hours are spent for emergency operation, including what classified the operation as emergency, and how many hours are spent for non-emergency operation.
- (c) If the engines are operated during a period that has been declared an "Emergency Alert Level 2" by an authorized entity, the owner/operator must keep records of the notification of the emergency situation, and the date, start time, and end time of the engine operation for this purpose.
- (d) If the engines are operated when there is a deviation of voltage or frequency of 5% or greater below standard voltage or frequency, the owner/operator must keep records of the notification of the emergency situation, and the date, start time, and end time of the engine operation for this purpose.

**SECTION E. Source Group Restrictions.**

(e) Maintain records of the maintenance conducted on the RICE.

**V. REPORTING REQUIREMENTS.**

No additional reporting requirements exist except as provided in other sections of this permit including Section B (Title V General Requirements).

**VI. WORK PRACTICE REQUIREMENTS.****# 005 [40 CFR Part 63 NESHAPS for Source Categories §40 CFR 63.6640]****Subpart ZZZZ - National Emissions Standards for Hazardous Air Pollutants for Stationary Reciprocating Internal Combustion Engines**

**How do I demonstrate continuous compliance with the emission limitations, operating limitations, and other requirements?**

(a) If you own or operate an existing stationary RICE located an area source of HAP emissions, you must comply with the requirements in Table 2d to Subpart ZZZZ and the operating limitations in Table 2d to Subpart ZZZZ that apply, including the following work practice standards.

- (1) Change oil and filter every 500 hours of operation or annually, whichever comes first.
- (2) Inspect the spark plugs every 1,000 hours of operation or annually, whichever comes first, and replace as necessary.
- (3) Inspect all hoses and belts every 500 hours of operation or annually, whichever comes first, and replace as necessary.

(b) Demonstrate continuous compliance by:

- (1) Operating and maintaining the RICE according to the manufacture's emission-related operation and maintenance instructions or
- (2) Develop and follow your own maintenance plan which must provide to the extent practicable for the maintenance and operation of the engine in a manner consistent with good air pollution control practice minimizing emissions.

**VII. ADDITIONAL REQUIREMENTS.****# 006 [25 Pa. Code §127.512]****Operating permit terms and conditions.**

	Manufacturer	Model	Throughput	Installation Date
SOURCE ID 101	Waukesha	L5108GSI	643 HP	1992
SOURCE ID 102	Waukesha	L5108GSI	804 HP	1992

**\*\*\* Permit Shield in Effect. \*\*\***



**SECTION E. Source Group Restrictions.**

Group Name: GROUP 02

Group Description: KILNS

Sources included in this group

ID	Name
149	KILN #1 - WAEZING SYSTEM
150	KILN #2 - WAEZING SYSTEM
152	KILN #5 - WAEZING SYSTEM

**I. RESTRICTIONS.****Emission Restriction(s).****# 001 [25 Pa. Code §123.13]****Processes**

(a) The concentration of particulate matter (expressed as TSP) in the emissions from these sources may not exceed 0.04 Grains per dry standard cubic foot of Total Suspended Particulate.

**# 002 [25 Pa. Code §123.21]****General**

(a) The concentration of the sulfur oxides, expressed as SO<sub>2</sub>, in the emissions from each source may not exceed 500 parts per million, by volume, of Sulfur Dioxide.

**# 003 [25 Pa. Code §127.512]****Operating permit terms and conditions.**

(a) To demonstrate compliance with Condition #002 of this GROUP 02, the permittee shall comply with the following requirements:

(b) The sulfur content of the #2 fuel oil fired by these sources shall not exceed 0.0015% Sulfur, by weight.

**II. TESTING REQUIREMENTS.****# 004 [25 Pa. Code §127.512]****Operating permit terms and conditions.**

(a) Whenever the back-up fuel is being used, the permittee shall perform an analysis of the No. 2 Fuel Oil. A representative sample shall be obtained and tested. The fuel characteristics to be determined shall include, but not be limited to, the percent (%) sulfur content, by weight. Testing shall be done in accordance with reference test methods identified in 25 Pa. Code 139.16. and 25 Pa. Code, Chapter 139.

(b) If the supplier of the oil can provide a certification of the value of the fuel characteristic mentioned in section (a) (specific to each shipment of No. 2 Fuel Oil delivered to the facility), the permittee may substitute such certification for the analysis of a representative sample.

**# 005 [25 Pa. Code §127.512]****Operating permit terms and conditions.**

(a) ALL EMISSIONS TESTING FOR THE GROUP 02 SOURCES SHALL BE CONDUCTED IN ACCORDANCE WITH THE TESTING REQUIREMENTS STATED IN TABLE 1A, 1B, AND 1C OF THE CONSENT DECREE FILED 06/23/2021 FOR BEFESA.

(b) At least two-weeks prior to the test, the Regional Air Quality Program Manager shall be informed of the date and time of the test.

(c) At least sixty (90) days prior to the test, a pre-test protocol shall be submitted to the Department for review.

**SECTION E. Source Group Restrictions.**

(d) Within sixty (60) days of the completion of the test, two copies of the complete test report, including all operating conditions, shall be submitted to the Regional Air Quality Program Manager and shall meet all applicable requirements specified in the most current version of the Department's Source Testing Manual.

(e) If at any time the Department has cause to believe that air contaminant emissions from these Sources may be in excess of the limitations specified in, or established pursuant to, any applicable rule or regulation contained in Article III of the Rules and Regulations of the Department of Environmental Protection, the company shall be required to conduct whatever tests are deemed necessary by the Department to determine the actual emission rate(s). Such testing shall be conducted in accordance with the revisions of Chapter 139 of the Rules and Regulations Environmental Protection, where applicable, and in accordance with any restrictions or limitations established by the Department at such time as it notified the company that testing is required.

(f) If the results of the stack test performed as required by this approval exceed the level specified in any condition of this approval, a retest to demonstrate compliance shall be performed within one hundred twenty (120) days of receipt of the original test results. Should the Permittee demonstrate to the Department that retesting in one hundred and twenty (120) days is not practicable, the Department may extend the retesting deadline. Failure of the second test to demonstrate compliance with the appropriate approval conditions may be grounds for immediate revocation of the approval to operate the affected source.

(g) After the initial stack testing, testing shall be conducted at a frequency of no more than five (5) years between subsequent stack tests.

(h) If compliance is demonstrated with the initial and subsequent stack testing, the frequency of the stack testing can be reduced with approval from the Department.

**# 006 [25 Pa. Code §139.11]****General requirements.**

The following are applicable to source tests for determining emissions from stationary sources:

(1) Performance tests shall be conducted while the source is operating at maximum routine operating conditions or under such other conditions, within the capacity of the equipment, as may be requested by the Department.

(2) The Department will consider for approval where sufficient information is provided to verify the source conditions existing at the time of the test and where adequate data is available to show the manner in which the test was conducted. Information submitted to the Department shall include, as a minimum all of the following:

- (i) A thorough source description, including a description of any air cleaning devices and the flue.
- (ii) Process conditions, for example, the charging rate of raw material or rate of production of final product, boiler pressure, oven temperature, and other conditions which may affect emissions from the process.
- (iii) The location of the sampling ports.
- (iv) Effluent characteristics, including velocity, temperature, moisture content, gas density (percentage CO, CO<sub>2</sub>, O<sub>2</sub> and N<sub>2</sub>), static and barometric pressures.
- (v) Sample collection techniques employed, including procedures used, equipment descriptions and data to verify that isokinetic sampling for particulate matter collection occurred and that acceptable test conditions were met.
- (vi) Laboratory procedures and results.
- (vii) Calculated results.

**III. MONITORING REQUIREMENTS.****# 007 [25 Pa. Code §127.511]****Monitoring and related recordkeeping and reporting requirements.**

(a) The permittee shall operate and maintain on each product collector a broken bag detector or differential pressure gauge. These monitoring devices shall be located as follows:

- (1) For Product Collectors C04, C05, C07, and C16, monitoring devices shall be located at either the product collector exhaust, or at the inlet and outlet of the product collector.
- (2) For all other Product Collectors, monitoring devices shall be located at either the product collector exhaust, or at the inlet and outlet of the product collector.

**SECTION E. Source Group Restrictions.**

(b) Particulate emission or differential pressures outside the operating parameters shall be monitored for on a daily basis.

**# 008 [25 Pa. Code §127.511]****Monitoring and related recordkeeping and reporting requirements.**

Visible emissions checks and product collector inspections shall be performed on a daily basis to ensure equipment is operating properly and bags are not deteriorating.

**# 009 [25 Pa. Code §127.511]****Monitoring and related recordkeeping and reporting requirements.**

(a) Mechanical gauges shall be installed and maintained to indicate, in inches of water column, the static pressure differential across the baghouses.

(b) The company shall monitor the opacity, pressure drop across the baghouse, feed rate, and inlet temperature continuously. The Continuous Emission Monitoring System (CEMS) for opacity must be approved by the Department and installed, operated, and maintained in accordance with the requirements of Chapter 139 of the Rules and Regulations of the Pennsylvania Department of Environmental Protection.

(c) The company shall ensure that the control devices shall be equipped with the applicable monitoring equipment and the monitoring equipment shall be installed, calibrated, operated, and maintained according to the vendor's specifications at all times the control device is in use.

**# 010 [25 Pa. Code §127.511]****Monitoring and related recordkeeping and reporting requirements.**

(a) During periods where the baghouse leak detection system is not functional or unavailable to use, the permittee shall use the following approved mean(s) or device(s) to measure the applicable indicator(s):

- (1) Baghouse differential pressure,
- (2) Baghouse inlet temperature sensor, and,
- (3) Continuous Operating Monitoring System (COMS).

**# 011 [25 Pa. Code §127.511]****Monitoring and related recordkeeping and reporting requirements.**

The permittee shall maintain the leak detection system in a manner consistent with the manufacturer's recommendations in order to provide continuous particulate matter monitoring from these sources

**# 012 [25 Pa. Code §127.511]****Monitoring and related recordkeeping and reporting requirements.**

The permittee shall maintain all continuous opacity monitors in accordance with the Quality Assurance and Performance Testing procedures specified in the most current publication of the DEP Continuous Source Monitoring Manual (Revision 8), and 25 Pa. Code, Chapter 139, Subchapter C (relating to requirements for continuous in-stack monitoring for stationary sources).

**IV. RECORDKEEPING REQUIREMENTS.****# 013 [25 Pa. Code §127.511]****Monitoring and related recordkeeping and reporting requirements.**

(a) The permittee shall maintain records of each incident of broken bags or abnormal operating conditions at any baghouse.

(b) The permittee shall maintain records of the daily baghouse inspections.

**SECTION E. Source Group Restrictions.****# 014 [25 Pa. Code §127.511]****Monitoring and related recordkeeping and reporting requirements.**

(a) The company shall maintain a file containing all records and other data that are required to be collected pursuant to the various provisions of this operating permit. The file shall include, but not be limited to, all air pollution control systems performance evaluations and records of calibration checks, adjustments and maintenance performed on all equipment, which is subject to this operating permit. All measurements, records and other data required to be maintained by the company shall be retained for at least five (5) years following the date on which such measurements, records or data are recorded.

(b) The company shall maintain daily records indicating the fuel type, average hourly firing rate, and total quantity used. These records must be maintained for a period of two (2) years and must be made available for review upon the Department's request.

(c) The company shall continuously record the baghouse inlet temperature, feed rate, and opacity.

**# 015 [25 Pa. Code §127.511]****Monitoring and related recordkeeping and reporting requirements.**

The permittee shall monitor and record data concerning Opacity of emissions from the kilns on a minute-by-minute basis.

**# 016 [25 Pa. Code §127.511]****Monitoring and related recordkeeping and reporting requirements.**

The permittee shall maintain sufficient records of operating time, fuel consumption, and raw materials consumption by these sources to determine compliance with the NOx and VOC limitations.

**# 017 [25 Pa. Code §127.511]****Monitoring and related recordkeeping and reporting requirements.**

The permittee shall operate and maintain continuous opacity monitoring devices that shall record the opacity of emissions from each of these sources on a minute-by-minute basis.

**# 018 [25 Pa. Code §127.511]****Monitoring and related recordkeeping and reporting requirements.**

(a) The permittee shall maintain records of all the daily baghouse differential pressure readings.

(b) All records shall include the date, time, and individual conducting the inspections.

**# 019 [25 Pa. Code §127.511]****Monitoring and related recordkeeping and reporting requirements.**

If the supplier of the oil can provide certification of the value of the fuel characteristic mentioned in section (a) (specific to each shipment of No. 2 Fuel Oil delivered to the facility), the permittee may substitute such certification (signed and notarized by a responsible official) for the analysis of a representative sample.

**V. REPORTING REQUIREMENTS.****# 020 [25 Pa. Code §127.511]****Monitoring and related recordkeeping and reporting requirements.**

Within four (4) hours of discovery of the occurrence, the permittee shall notify the Department of any malfunction of a bag filter collector, or its attendant source, which has resulted in, or may possibly result in, the emission of air contaminants in excess of applicable requirements for visible emissions, as set forth in SECTION C - Condition #004.

**SECTION E. Source Group Restrictions.****# 021 [25 Pa. Code §127.511]****Monitoring and related recordkeeping and reporting requirements.**

On a quarterly basis, the permittee shall compile an Opacity Emission Report from the Opacity CEM data of the hourly average opacity, during the preceding 3 months. Opacity shall be expressed as a percentage (%). These reports shall be submitted to the Department within thirty (30) days of the close of each quarterly period. The Department reserves the right to require that any CEM reports made requisite by the conditions of this permit be submitted upon floppy disk, with a format acceptable to the Department.

**VI. WORK PRACTICE REQUIREMENTS.****# 022 [25 Pa. Code §127.512]****Operating permit terms and conditions.**

The company shall keep on hand a sufficient quantity of spare product collector bags for the product collectors associated with the GROUP 02 SOURCES in order to be able to immediately replace any bags requiring replacement due to deterioration resulting from routine operation of the sources and product collectors.

**# 023 [25 Pa. Code §127.512]****Operating permit terms and conditions.**

The permittee shall perform preventive maintenance and service on collection and monitoring equipment as recommended by the manufacture.

**VII. ADDITIONAL REQUIREMENTS.****# 024 [25 Pa. Code §127.512]****Operating permit terms and conditions.**

The company shall not impose conditions upon or otherwise restrict the Department's access to the GROUP 02 SOURCES and/or any associated air cleaning devices and shall allow the Department to have access at any time to said sources and associated air cleaning devices with such measuring and recording equipment, including equipment recording visual observations, as the Department deems necessary and proper for performing its duties and for the effective enforcement of the Air Pollution Control Act.

**\*\*\* Permit Shield in Effect. \*\*\***

**SECTION E. Source Group Restrictions.**

Group Name: GROUP 03

Group Description: KILN DISCHARGE - CAM PLAN

Sources included in this group

ID	Name
238	F2 KILN DISCHARGE AREA FUGITIVE DUST - KILN #5
239	F1 KILN DISCHARGE AREA FUGITIVE DUST - KILN #1 AND #2

**I. RESTRICTIONS.****Emission Restriction(s).****# 001 [25 Pa. Code §123.13]****Processes**

(a) The concentration of particulate matter (expressed as TSP) in the emissions from these sources may not exceed 0.04 Grains per dry standard cubic foot of Total Suspended Particulate.

**# 002 [25 Pa. Code §127.512]****Operating permit terms and conditions.**

The Company shall comply with the following emission limits approved 05/16/1995 in RACT 1 permit:

SOURCE	NOX RATE	VOC RATE
Fugitive Baghouse (SOURCE ID 238)	0.4 lbs./hr.	0.3 lbs./hr.
Fugitive Baghouse (SOURCE ID 239)	0.4 lbs./hr.	0.2 lbs./hr.

**II. TESTING REQUIREMENTS.****# 003 [25 Pa. Code §127.512]****Operating permit terms and conditions.**

(a) Within 180 days of the issuance of this TV permit, a stack test shall be performed in accordance with the provision of Chapter 139 of the Rules and Regulations of the Department of Environmental Protection to demonstrate the compliance with the emission limitations in this section for SOURCE ID 238 and SOURCE ID 239. The stack tests shall be performed for SOX, NOX, and VOC's, and with the sources operating at the maximum rated capacity. If testing is performed at a rate of less than full production, operation is restricted to the process-input rate of testing at such level until a subsequent compliance test is performed at a full production.

(b) At least two-weeks prior to the test, the Regional Air Quality Program Manager shall be informed of the date and time of the test.

(c) At least sixty (60) days prior to the test, a pre-test protocol shall be submitted to the Department for review.

(d) Within sixty (90) days of the completion of the test, two copies of the complete test report, including all operating conditions, shall be submitted to the Regional Air Quality Program Manager and shall meet all applicable requirements specified in the most current version of the Department's Source Testing Manual.

(e) If at any time the Department has cause to believe that air contaminant emissions from these Sources may be in excess of the limitations specified in, or established pursuant to, any applicable rule or regulation contained in Article III of the Rules and Regulations of the Department of Environmental Protection, the company shall be required to conduct whatever tests are deemed necessary by the Department to determine the actual emission rate(s). Such testing shall be conducted in accordance with the revisions of Chapter 139 of the Rules and Regulations Environmental Protection, where applicable, and in accordance with any restrictions or limitations established by the Department at such time as it notified the company that testing is required.

(f) If the results of the stack test performed as required by this approval exceed the level specified in any condition of this

**SECTION E. Source Group Restrictions.**

approval, a retest to demonstrate compliance shall be performed within one hundred twenty (120) days of receipt of the original test results. Should the Permittee demonstrate to the Department that retesting in one hundred and twenty (120) days is not practicable, the Department may extend the retesting deadline. Failure of the second test to demonstrate compliance with the appropriate approval conditions may be grounds for immediate revocation of the approval to operate the affected source.

(g) After the initial stack testing, testing shall be conducted at a frequency of no more than five (5) years between subsequent stack tests.

(h) If compliance is demonstrated with the initial and subsequent stack testing, the frequency of the stack testing can be reduced with approval from the Department.

**III. MONITORING REQUIREMENTS.****# 004 [25 Pa. Code §127.511]****Monitoring and related recordkeeping and reporting requirements.**

Compliance with the particulate matter emission restriction shall be demonstrated by daily monitoring of the pressure differential across the control devices for these sources.

**# 005 [25 Pa. Code §127.511]****Monitoring and related recordkeeping and reporting requirements.**

(a) The permittee shall operate and maintain on each control device a broken bag detector or differential pressure gauge. These monitoring devices shall be located as follows:

(1) Monitoring devices shall be located at either the bag filter collector exhaust, or at the inlet and outlet of the bag filter collector.

(b) Particulate emission or differential pressures outside the operating parameters shall be monitored for on a daily basis.

(c) Visible emissions checks and baghouse inspections shall be performed on a daily basis to ensure equipment is operating properly and bags are not deteriorating.

**IV. RECORDKEEPING REQUIREMENTS.****# 006 [25 Pa. Code §127.511]****Monitoring and related recordkeeping and reporting requirements.**

The permittee shall maintain records of each incident of broken bags or abnormal operating conditions at any collector.

**# 007 [25 Pa. Code §127.511]****Monitoring and related recordkeeping and reporting requirements.**

The permittee shall maintain records of the daily baghouse inspections.

**# 008 [25 Pa. Code §127.511]****Monitoring and related recordkeeping and reporting requirements.**

(a) The permittee shall maintain records of all the daily baghouse differential pressure readings.

(b) All records shall include the date, time, and individual conducting the inspections.

**V. REPORTING REQUIREMENTS.****# 009 [25 Pa. Code §127.511]****Monitoring and related recordkeeping and reporting requirements.**

Within four (4) hours of the occurrence, the permittee shall notify the Department of any malfunction of a bag filter collector, or its attendant source, which has resulted in, or may possibly result in, the emission of air contaminants in excess of applicable requirements for visible emissions, as set forth in SECTION C - Condition #004.

**SECTION E. Source Group Restrictions.****VI. WORK PRACTICE REQUIREMENTS.****# 010 [25 Pa. Code §127.511]****Monitoring and related recordkeeping and reporting requirements.**

[Additional authority for this permit condition is also derived from 40 CFR 64.3 and 64.6, Compliance Assurance Monitoring.]

(1) The permittee shall adhere to the approved operating ranges and selected indicators stated in the Compliance Assurance Monitoring Plan approved by the Department so that operation within the ranges shall provide reasonable assurance of compliance. The permittee shall provide the Department this Compliance Assurance Monitoring Plan within twelve (12) months of permit issuance or sooner. A departure from the specified indicator ranges over a specified averaging period shall be defined as an excursion.

(2) The approved ranges and selected indicators shall be determined by the facility after conducting the appropriate testing and shall be included in the Compliance Assurance Monitoring Plan. Acceptable ranges shall be established, at a minimum, for the following:

- (a) Baghouse differential pressure
- (b) Baghouse outlet particulate sensor signal.
- (c) Visible Emissions.

**# 011 [25 Pa. Code §127.511]****Monitoring and related recordkeeping and reporting requirements.**

If requested by the Department, the permittee shall implement a QIP (Quality Improvement Plan) for the fabric collectors (baghouses) in accordance with the Compliance Assurance Monitoring (CAM) requirements of 40 CFR 64.4, 64.8 and 64.9.

**# 012 [25 Pa. Code §127.511]****Monitoring and related recordkeeping and reporting requirements.**

[Additional authority for this permit condition is also derived from 40 CFR Section 64.4, 64.8, 64.9, Compliance Assurance Monitoring.]

(a) The permittee shall submit and implement a quality improvement plan (QIP) as expeditiously as possible if any of the following occurs:

- (1) For properly and accurately collected data, accumulated excursions exceed five percent (5%) of the data for particulates.
- (2) Six excursions occur in a six-month period.
- (3) The Department determines after review of all reported information that the permittee has not responded acceptably to an excursion.

(b) In general, the QIP (Quality Improvement Plan) should be developed within 60 days and the permittee shall provide a copy of the QIP to the Department. Furthermore, the permittee shall notify the Department if the period for completing the improvements contained in the QIP exceeds 180 days from the date on which the need to implement the QIP was determined.

(c) The permittee shall submit an implementation plan and schedule if the approved monitoring requires the installation, testing or other necessary activities. The schedule for completing installation and beginning operation of the monitoring may not exceed 180 days after the issuance date of the permit.

(d) The permittee shall record actions taken to implement a QIP during a reporting period and all related actions including, but not limited to inspections, repairs and maintenance performed on the monitoring equipment.

(e) Following implementation of a QIP, the Department will require reasonable revisions to the QIP if the plan has failed to either:

- (1) Address the cause of the control device performance problem.
- (2) Provide adequate procedures for correcting control device performance problems in as expeditiously as possible in accordance with good air pollution control practices for minimizing emissions.

(f) Implementation of a QIP, shall not excuse the owner or operator of a source from compliance with any existing emission



**SECTION E. Source Group Restrictions.**

limitation or standard or any existing monitoring, testing, reporting or recordkeeping requirements that may apply under any federal, state, or local laws or any other applicable requirements under the Clean Air Act.

(g) In accordance with Section 64.8, the QIP shall include procedures for evaluating the control performance problems. Based on the results of the evaluation procedures, the permittee shall modify the QIP, and provide a copy to the Department, to include procedures for conducting more frequent or improved monitoring in conjunction with one or more of the following:

- (1) Improved preventive maintenance practices.
- (2) Process operation changes.
- (3) Appropriate improvements to control methods.
- (4) Other steps appropriate to correct performance.

[Additional authority for this permit condition is also derived from 40 CFR Section 64.3.]

(a) The permittee shall utilize approved QA/QC practices that are adequate to ensure continuing validity of data and proper performance of the devices.

- (1) The permittee shall, for an approved device(s) install detectors or sensors at a location approved by the Department for obtaining data that are representative of the monitored indicator.
- (2) The permittee shall develop verification procedures to confirm the operational status of new or modified monitoring equipment prior to commencement of the monitoring process.

**# 013 [25 Pa. Code §127.512]****Operating permit terms and conditions.**

The company shall keep on hand a sufficient quantity of spare fabric collector bags for the fabric collectors associated with these GROUP 03 Sources in order to be able to immediately replace any bags requiring replacement due to deterioration resulting from routine operation of the sources and fabric collectors.

**# 014 [25 Pa. Code §127.512]****Operating permit terms and conditions.**

The permittee shall perform preventative maintenance and service on collection and monitoring equipment as recommended by the manufacture.

**VII. ADDITIONAL REQUIREMENTS.****# 015 [25 Pa. Code §127.512]****Operating permit terms and conditions.**

The company shall not impose conditions upon or otherwise restrict the Department's access to the GROUP 03 SOURCES and/or any associated air cleaning devices and shall allow the Department to have access at any time to said sources and associated air cleaning devices with such measuring and recording equipment, including equipment recording visual observations, as the Department deems necessary and proper for performing its duties and for the effective enforcement of the Air Pollution Control Act.

**\*\*\* Permit Shield in Effect. \*\*\***

**SECTION E. Source Group Restrictions.**

Group Name: GROUP 04

Group Description: CONTROLLED PROCESSES

Sources included in this group

ID	Name
230	CZO RECEIVING SILO
233	EAF DUST FEED HOPPER LOADING - BUILDING 608
234	EAF DUST TRESTLE CONVEYOR TRANSFER SYS.- BLD. 608
235A	EAF DUST RAILCAR UNLOADING HOPPER
235B	EAF DUST HOPPER CONVEYOR TRANSFER
236	EAF DUST PELLETIZER MATERIAL CONVEYOR TRANSFER - BLDG 608
237	CZO LOADING SPOUT
245	KILN FEED BINS
246	EAF DUST TRESTLE SILOS
248CTR	CENTER CZO RECEIVING BIN
248NT	NORTH CZO RECEIVING BIN
248ST	SOUTH CZO RECEIVING BIN

**I. RESTRICTIONS.****Emission Restriction(s).**

# 001 [25 Pa. Code §123.13]

**Processes**

The emission of particulate matter from each of these sources may not exceed 0.04 grains per dry standard cubic foot of exhaust volume.

# 002 [25 Pa. Code §123.21]

**General**

The concentration of sulfur oxides, expressed as SO<sub>2</sub>, in the emissions from each source may not exceed 500 parts per million, by volume of Sulfur Dioxide, over any 1- hour period.

# 003 [25 Pa. Code §127.511]

**Monitoring and related recordkeeping and reporting requirements.**

At all times that these sources are in operation, the associated air pollution control devices shall also be in operation to ensure compliance with the facility-wide limitation on emissions of particulate matter.

**II. TESTING REQUIREMENTS.**

No additional testing requirements exist except as provided in other sections of this permit including Section B (Title V General Requirements).

**III. MONITORING REQUIREMENTS.**

# 004 [25 Pa. Code §127.511]

**Monitoring and related recordkeeping and reporting requirements.**

Compliance with the particulate matter emission restriction shall be demonstrated by daily monitoring of the pressure differential across the control devices for these sources.

# 005 [25 Pa. Code §127.511]

**Monitoring and related recordkeeping and reporting requirements.**

(a) The permittee shall operate and maintain on each Control Device a broken bag detector or differential pressure gauge.

**SECTION E. Source Group Restrictions.**

These monitoring devices shall be located as follows:

- (1) Monitoring devices shall be located at either the bag filter collector exhaust, or at the inlet and outlet of the bag filter collector.
- (b) Particulate emission or differential pressures outside the operating parameters shall be monitored for on a daily basis.
- (c) Visible emissions checks and baghouse inspections shall be performed on a daily basis to ensure equipment is operating properly and bags are not deteriorating.

**IV. RECORDKEEPING REQUIREMENTS.**

**# 006 [25 Pa. Code §127.511]**

**Monitoring and related recordkeeping and reporting requirements.**

The permittee shall maintain records of each incident of broken bags or abnormal operating conditions at any collector.

**# 007 [25 Pa. Code §127.511]**

**Monitoring and related recordkeeping and reporting requirements.**

The permittee shall maintain records of the daily baghouse inspections.

**# 008 [25 Pa. Code §127.511]**

**Monitoring and related recordkeeping and reporting requirements.**

- (a) The permittee shall maintain records of all the daily baghouse differential pressure readings.
- (b) All records shall include the date, time, and individual conducting the inspections.

**V. REPORTING REQUIREMENTS.**

**# 009 [25 Pa. Code §127.511]**

**Monitoring and related recordkeeping and reporting requirements.**

Within four (4) hours of the occurrence, the permittee shall notify the Department of any malfunction of a bag filter collector, or its attendant source, which has resulted in, or may possibly result in, the emission of air contaminants in excess of applicable requirements for visible emissions, as set forth in SECTION C - Condition #004.

**VI. WORK PRACTICE REQUIREMENTS.**

**# 010 [25 Pa. Code §127.511]**

**Monitoring and related recordkeeping and reporting requirements.**

- (a) These sources may be operated and used only as long as the associated air pollution control devices and monitoring equipment are operated and maintained in accordance with the manufacturer specifications.
- (b) The company shall keep on hand a sufficient quantity of spare fabric collector bags for the fabric collectors associated with the GROUP 04 SOURCES in order to be able to immediately replace any bags requiring replacement due to deterioration resulting from routine operation of the sources and fabric collectors.
- (c) The permittee shall perform preventative maintenance and service on collection and monitoring equipment as recommended by the manufacture.

**VII. ADDITIONAL REQUIREMENTS.**

No additional requirements exist except as provided in other sections of this permit including Section B (Title V General Requirements).



**SECTION E. Source Group Restrictions.**

**\*\*\* Permit Shield in Effect. \*\*\***

**SECTION E. Source Group Restrictions.**

Group Name: GROUP 05

Group Description: 129.91-129.95 RACT 1 SOURCES and SIP REQUIREMENTS

**Sources included in this group**

ID	Name
149	KILN #1 - WAEZING SYSTEM
150	KILN #2 - WAEZING SYSTEM
152	KILN #5 - WAEZING SYSTEM
238	F2 KILN DISCHARGE AREA FUGITIVE DUST - KILN #5
239	F1 KILN DISCHARGE AREA FUGITIVE DUST - KILN #1 AND #2

**I. RESTRICTIONS.**

No additional requirements exist except as provided in other sections of this permit including Section B (Title V General Requirements).

**II. TESTING REQUIREMENTS.**

No additional testing requirements exist except as provided in other sections of this permit including Section B (Title V General Requirements).

**III. MONITORING REQUIREMENTS.**

No additional monitoring requirements exist except as provided in other sections of this permit including Section B (Title V General Requirements).

**IV. RECORDKEEPING REQUIREMENTS.**

No additional record keeping requirements exist except as provided in other sections of this permit including Section B (Title V General Requirements).

**V. REPORTING REQUIREMENTS.**

No additional reporting requirements exist except as provided in other sections of this permit including Section B (Title V General Requirements).

**VI. WORK PRACTICE REQUIREMENTS.**

No additional work practice requirements exist except as provided in other sections of this permit including Section B (Title V General Requirements).

**VII. ADDITIONAL REQUIREMENTS.**

**# 001 [25 Pa. Code §129.91]  
Control of major sources of NOx and VOCs**

THE FOLLOWING CONDITIONS WERE OBTAINED FROM RACT 1 OPERATING PERMIT #13-0001 ISSUED MAY 16, 1995:

This permit is subject to the following conditions:

- (1) That the source and any associated air cleaning devices are to be:
  - (a) operated in such a manner as not to cause air pollution;
  - (b) operated and maintained in a manner consistent with good operating and maintenance practices.
- (2) This permit is valid only for the specific equipment, location, and owner named above.
- (3) In accordance with Sections 6.3(e) and 6.3(d) of the Pennsylvania Air Pollution Control Act (as amended) a two hundred fifty dollar (\$250.00) annual operating permit administrative fee is required each year. This administrative fee is to be submitted thirty (30) days prior to the anniversary date of this operating permit; and is to be submitted with the attached transmittal form.

**SECTION E. Source Group Restrictions.**

(4) This Operating Permit is valid for a limited time and may be renewed before its expiration. Requests for an Operating Permit Renewal must be in writing and must be accompanied by a permit fee in the amount of five hundred dollars (\$500.00) payable to the "Commonwealth of Pennsylvania - Clean Air Fund" (\$250.00 application processing fee and \$250.00 annual administrative. The request should be made on an Interim Application for Renewal of a Permit to Operate form and must be received by the Department along with a completed Compliance History form no later than the first of the month in which the permit expires.

(5) This Operating Permit will cover the operation of the minor sources referenced on Page One (I), listed as follows:

Source	NOX Rate	VOC Rate
Boiler #66 (15MMBTU/Hr.)	2.1 lbs./hr.	Negligible
Boiler #67 (20MMBTU/Hr.)	2.8 lbs./hr.	Negligible
Fugitive Baghouse	0.4 lbs./hr.	0.3 lbs./hr.
Fugitive Baghouse	0.3 lbs./hr.	0.2 lbs./hr.

(6) On or before July 31, 1995, a test procedure and a sketch with dimensions indicating the location of sampling ports and other data for one (1) of the Waelz Kilns and one (1) of the Calcine Kilns listed Condition #10 of this RACT 1 Operating Permit, to ensure the collection of representative samples, shall be submitted to the Regional Air Quality Program Manager.

(7) On or before October 31, 1995, stack tests shall be performed in accordance with the provisions of Chapter 139 of the Rules and Regulations of the Department of Environmental Resources to show compliance with Nitrous Oxide emission rates and Volatile Organic emission rates listed in the company's RACT proposal, and listed in Condition #10 of this RACT 1 Operating Permit. The stack tests shall be performed while the Department designated Kilns are operating at the maximum rated capacity as stated in the RACT application. The Waelz and Calcine Kilns that will be tested as a requirement of this operating permit will be selected by the Department, and must not exceed the limits specified in Condition #10 of this RACT Operating Permit.

(8) At least two weeks prior to the tests, the Regional Air Quality Program Manager shall be informed of the date and time of the tests.

(9) On or before December 31, 1995, two (2) copies of the complete stack test reports, including all operating conditions, shall be submitted to the Regional Air Quality Program Manager.

(10) The Nitrous Oxide and Volatile Organic Compound emission rates for each of the Kilns is listed as follows:

Source	NOX Limit	VOC Limit
Kiln #1	3.0 #/Hr.	0.2 #/Hr.
Kiln #2	9.9 #/Hr.	19.3 #/Hr.
Kiln #3	8.8 #/Hr.	14.2 #/Hr.
Kiln #5	12.3 #/Hr.	15.2 #/Hr.
Kiln #6	5.3 #/Hr.	0.3 #/Hr.

(11) The Nitrous Oxide and Volatile Organic Compound emission rates for each of the four (4) sources listed in Condition (5) of this RACT Operating Permit, is dependent upon the equipment being operated and maintained according to the manufacturer's specifications for its equipment. The company is therefore required by this RACT Operating Permit, to meet presumptive RACT as specified in Chapter 129.93(c)(1) of the Rules and Regulations of the Department of Environmental Resources by operating and maintaining all of the sources listed in Condition Number (5) according to each of the manufacturer's specifications.

\*\*\* **Permit Shield in Effect.** \*\*\*

**SECTION E. Source Group Restrictions.**

Group Name: GROUP 06

Group Description: RACT 2 - Case by Case NOx Sources

Sources included in this group

ID	Name
149	KILN #1 - WAE LZING SYSTEM
150	KILN #2 - WAE LZING SYSTEM
152	KILN #5 - WAE LZING SYSTEM

**I. RESTRICTIONS.****Emission Restriction(s).****# 001 [25 Pa. Code §129.96]****Applicability**

[Additional authority for below, is also derived from 25 Pa. Code § 129.99(b).]

NOx Emissions from the Kilns equipped with low NOx burners shall not exceed the following:

1. Source ID 149	
Waelzing Mode	NOx 8.20 lbs./hr.
2. Source ID 150 Kiln #2	9.9 lbs./hr.
3. Source ID 152 Kiln #5	12.3 lbs./hr.

**II. TESTING REQUIREMENTS.****# 002 [25 Pa. Code §129.96]****Applicability**

Additional authority for this permit condition is also derived from 25 Pa. Code § 129.100]

§ 129.100. Compliance demonstration and recordkeeping requirements

(a) Except as provided in subsection (c), the owner and operator of an air contamination source subject to a NOx requirement or RACT emission limitation or VOC requirement or RACT emission limitation, or both, listed in § 129.97 (relating to presumptive RACT requirements, RACT emission limitations and petition for alternative compliance schedule) shall demonstrate compliance with the applicable RACT requirement or RACT emission limitation by performing the following monitoring or testing procedures:

- (1) N/A.
- (2) N/A.
- (3) N/A.

(4) For an air contamination source without a CEMS, monitoring and testing in accordance with a Department approved emissions source test that meets the requirements of Chapter 139, Subchapter A (relating to sampling and testing methods and procedures). The source test shall be conducted one time in each 5-year calendar period.

(b) Except as provided in § 129.97(k) and § 129.99(i) (relating to alternative RACT proposal and petition for alternative compliance schedule), the owner and operator of an air contamination source subject to subsection (a) shall demonstrate compliance with the applicable RACT requirement or RACT emission limitation in accordance with the procedures in subsection (a) not later than:

(1) Source Tests shall be conducted within 180 days of the effective date after the issuance of this Title V Operating Permit.

(c) N/A.

**SECTION E. Source Group Restrictions.****III. MONITORING REQUIREMENTS.**

No additional monitoring requirements exist except as provided in other sections of this permit including Section B (Title V General Requirements).

**IV. RECORDKEEPING REQUIREMENTS.****# 003 [25 Pa. Code §129.96]****Applicability**

[Additional authority for this permit condition is also derived from 25 Pa. Code § 129.100(d).]

(a) The permittee shall maintain records to show compliance of NOx emissions from these sources, as applicable, and shall keep records of the NOx emissions pursuant to 25 Pa. Code §129.100.

(b) The permittee shall maintain sufficient records to demonstrate compliance with RACT II requirements.

**# 004 [25 Pa. Code §129.96]****Applicability**

(d) The owner and operator of an air contamination source subject to this section and §§ 129.96—129.99 shall keep records to demonstrate compliance with §§ 129.96—129.99 in the following manner:

(1) The records must include sufficient data and calculations to demonstrate that the requirements of §§ 129.96—129.99 are met.

(2) Data or information required to determine compliance shall be recorded and maintained in a time frame consistent with the averaging period of the requirement.

The permittee shall operate and maintain these kilns in accordance with the manufacturer's specifications and good air pollution control practices.

**V. REPORTING REQUIREMENTS.**

No additional reporting requirements exist except as provided in other sections of this permit including Section B (Title V General Requirements).

**VI. WORK PRACTICE REQUIREMENTS.**

No additional work practice requirements exist except as provided in other sections of this permit including Section B (Title V General Requirements).

**VII. ADDITIONAL REQUIREMENTS.**

No additional requirements exist except as provided in other sections of this permit including Section B (Title V General Requirements).

**\*\*\* Permit Shield in Effect. \*\*\***



**SECTION E. Source Group Restrictions.**

Group Name: GROUP 07

Group Description: VOC LIMITS ON KILNS - PLAN APPROVAL #13-00001B

Sources included in this group

ID	Name
149	KILN #1 - WAE LZING SYSTEM
150	KILN #2 - WAE LZING SYSTEM
152	KILN #5 - WAE LZING SYSTEM

**I. RESTRICTIONS.****Emission Restriction(s).****# 001 [25 Pa. Code §127.512]****Operating permit terms and conditions.**

VOC emissions from the facility shall never equal or exceed 50 TPY, based on a 12-month rolling sum.

**# 002 [25 Pa. Code §127.512]****Operating permit terms and conditions.**

VOC emission limits for each of the kilns, as tested at the product collector, are as follows:

Source	Operating Mode	VOC Emission Limit (lbs./hr.)
149	Kiln #1 Waelzing	2.0
150	Kiln #2 Waelzing	2.0
152	Kiln #5 Waelzing	2.0

**II. TESTING REQUIREMENTS.****# 003 [25 Pa. Code §127.512]****Operating permit terms and conditions.**

1. Within 180 days of initial start-up, a performance test shall be conducted in accordance with the provisions of Chapter 139 of the Rules and Regulations of the Department of Environmental Protection to demonstrate the compliance with the VOC emission limitations set by the conditions above for the kiln product collectors. Performance tests shall be conducted while the sources are operating at maximum routine operating conditions or under such other conditions, within the capacity of the equipment, as may be requested by the Department.
2. At least ninety (90) calendar days prior to commencing an emission testing program required by this permit, a test protocol shall be submitted to the Department's Division of Source Testing and Monitoring and the Regional Office for review and approval. The test protocol shall meet all applicable requirements specified in the most current version of the Department's Source Testing Manual.
3. At least fifteen (15) calendar days prior to commencing an emission testing program required by this permit, written notification of the date and time of testing shall be provided to the Department's appropriate Regional Office. Written notification shall also be sent to the Department's Bureau of Air Quality, Division of Source Testing and Monitoring. The notification shall not be made without prior receipt of a protocol acceptance letter from the Department. The Department is under no obligation to accept the results of any testing performed without adequate advance written notice to the Department of such testing. In addition, the emissions testing shall not commence prior to receipt of a protocol acceptance letter from the Department.
4. A complete test report shall be submitted to the Department no later than sixty (60) calendar days after completion of the on-site testing portion of an emission test program.
5. A complete test report shall include a summary of the emission results on the first page of the report indicating if each pollutant measured is within permitted limits and a statement of compliance or non-compliance with all applicable permit conditions. The summary results will include, at a minimum, the following information:

**SECTION E. Source Group Restrictions.**

- a. A statement that the owner or operator has reviewed the report from the emissions testing body and agrees with the findings;
- b. Permit number(s) and condition(s) which are the basis for the evaluation;
- c. Summary of results with respect to each applicable permit condition; and
- d. Statement of compliance or non-compliance with each applicable permit condition.

**# 004 [25 Pa. Code §127.512]****Operating permit terms and conditions.**

The owner or operator shall conduct performance tests for VOC's at any time or interval of time as may be prescribed by the Department. At a minimum, unless altered by the Department, the company shall conduct performance tests within 180 days of initial start-up, as required under Condition #003 above, and thereafter at a frequency of no more than two (2) years between subsequent tests to demonstrate compliance with VOC emission limits (both Calcining and Waelzing modes) for the product collectors (source ID #s C04, C05, C07 and C16) contained in Condition #002 above.

The Department may reduce this testing requirement, at its discretion, following receipt and review of a request for such a reduction from BEFESA.

**III. MONITORING REQUIREMENTS.**

No additional monitoring requirements exist except as provided in other sections of this permit including Section B (Title V General Requirements).

**IV. RECORDKEEPING REQUIREMENTS.****# 005 [25 Pa. Code §127.512]****Operating permit terms and conditions.**

(a) The permittee shall maintain updated records of VOC emissions, based on a 12 month rolling sum, to demonstrate compliance with the 50 TPY facility emission limit.

(b) These records shall be kept and made available to the Department upon request.

**V. REPORTING REQUIREMENTS.****# 006 [25 Pa. Code §127.512]****Operating permit terms and conditions.**

(a) The permittee shall submit reports to the Department on a quarterly basis that include the supporting calculations to verify compliance with the VOC emissions limitations for the facility in any 12 consecutive month period. Reports shall be submitted to the Department within thirty (30) days of the close of the calendar quarter (March 31, June 30, September 30 and December 31). The permittee shall send this report to the Department by e-mail (to the Regional Air Quality Program Manager).

(b) These reports shall also be submitted to the Department upon request.

**VI. WORK PRACTICE REQUIREMENTS.**

No additional work practice requirements exist except as provided in other sections of this permit including Section B (Title V General Requirements).

**VII. ADDITIONAL REQUIREMENTS.**

No additional requirements exist except as provided in other sections of this permit including Section B (Title V General Requirements).

**\*\*\* Permit Shield in Effect. \*\*\***

**SECTION F. Alternative Operation Requirements.**

No Alternative Operations exist for this Title V facility.



**SECTION G. Emission Restriction Summary.**

No emission restrictions listed in this section of the permit.

**SECTION H. Miscellaneous.**

(a) The Department received the operating permit application for this facility on 09/25/2018. The facility is required to pay an Annual Operating Permit Maintenance Fee in accordance with Pennsylvania Code, Title 25, Chapter 127, Section 127.704(d). The Annual Maintenance Fee is due on or before December 31 of each year for the next calendar year.

(b) This permit is a renewal of Operating Permit No. TV 13-00001 issued 03-25-2013 and TV 13-00001 Amendment including RACT II requirements issued 03-25-2019 - (ID 149,150,152,153).

SINCE THE SUBMISSION OF THE APPLICATION SOURCE ID 153 (KILN #6) IS NO LONGER OPERATING.

This permit also includes conditions from the following:

PLAN APPROVAL #13-00001B issued 10-22-2020 to establish VOC limits on the kilns, tested at the product collectors (currently source ID #s C04, C05, C07 and C16) operating on Kiln #s 1, 2, 5 and 6, while operating in both waelzing and calcining modes, in order to keep facility emissions below the major source threshold of 50 TPY of VOCs.

Source ID 101 - Plan Approval #13-308-095.

Source ID 102 - Plan Approval #13-308-094.

Source ID 103 - Plan Approval #13-308-104 issued 02-27-2004.

Source ID 149 (Kiln #1) - Plan Approval #13-308-093 issued 03-24-1994 and Plan Approval #13-308-104 issued 02-27-2004.

Source ID 150 (Kiln #2) - Plan Approval #13-308-094 issued 03-24-1994 and Plan Approval #13-308-104 issued 02-27-2004.

Source ID 152 (Kiln #5) - Plan Approval #13-308-095 issued 03-24-1994 and Plan Approval #13-308-104 issued 02-27-2004.

Source ID 153 (Kiln #6) - Plan Approval #13-308-091 issued 03-24-1994 and Plan Approval #13-308-104 issued 02-27-2004.

Source ID 230 - Plan Approval #13-008-088 and Operating Permit No. TV 13-00012 issued 04-21-2004.

Source ID 231 - Plan Approval #13-308-086 and Operating Permit No. TV 13-00012 issued 04-21-2004.

Source ID 233 - Plan Approval #13-308-083A.

Source ID 234 - Plan Approval #13-308-081.

Source ID 235 - Plan Approval #13-308-001.

Source ID 236 - Plan Approval #13-308-087A.

Source ID 237 - Plan Approval #13-308-089.

Source ID 238 - Plan Approval 13-308-091 and CAM PLAN.

Source ID 239 - Plan Approval 13-308-091 and CAM PLAN.

Source ID 242 - NA.

Source ID 244 - NA.

Source ID 245 - Plan Approval #13-308-103.

Source ID 246 - Plan Approval #13-399-003.

Source ID 248 - Plan Approval #13-399-008A and #13-399-008B issued 07-28-2004.

(c) This is a Title V Operating Permit facility.

(d) The following is a list of sources that have been determined by the Department to be of minor significance under 25 Pa. Code, Chapter 127, Section 127.14(a)(8) and are not regulated in this TV Operating Permit. However, this determination does not exempt the sources from compliance with all applicable air quality regulations specified in 25 Pa. Code Chapters 121-143:

(1) Service Building Complex - Spare Parts Room, Clothing Storage Room, Supplies Room, Shower Area, Old Welder's Booth, Restroom, Welder's Booth, Electric Shop Work Bench, Compressed Air Exhaust Ports (3), Electric Shop Parts Cleaning.

(2) Mobile Shop - Steam Jenny, East Work Area, Compressed Air Blowdown, Sand Blasting Unit, West Work Area, Payloader Exhaust Fume, Battery Charging Station, Air Filter Blowdown Booth.

(3) Blender Building - Compressed Air receiver Tank, Pressure Relief Valve.

(4) Waelz Kilns Product Collector Complex - East Silo, West Silo.

(5) Substation 43 - East Room, West Room, Center Room.

(6) Main Change House - Dryer Outlets (2), Rotary Draft Louvers (4), Restroom.

(7) Lunch Room - Attic Area, Sewer.

(8) #6 Product Collector Motor Control Center - Controller Room.

(9) Air Compressor Room - Compressed Air System Pressure, Relief Valves.

(10) Substation 10 - Vent Fan (1).

(11) Mobile Shop - Steam Jenny, East Wall.

**SECTION H. Miscellaneous.**

- (12) Compressor Room - South Wall.
- (13) Sample Room - Dry Oven, Wall Exhaust, Sewage.
- (14) Kiln Area - Steam Systems for Kilns.

(e) List of RFD's:

- (1) 13-0138 approved 03/11/2008 for the addition of pelletizing unit incorporated into the existing feed handling system at the C6-C7 transfer point.
- (2) 13-0149 approved 09/26/2012 to allow Kiln #1 and Kiln #6 to operate in the Calcium Mode up to the maximum feed rate of each kiln or  $500\text{tpd} + 304\text{tpd} = 804\text{tpd}$ .
- (3) 13-0150 approved 05/09/2013 for three silos to store crude zinc oxide.
- (4) 13-0151 approved 05/09/2013 to revise loading silo from railcar rather than truck.
- (5) 13-0152 approved 05/09/2013 for change lead handling area to CZO handling.
- (6) 13-0159 approved 12/13/2019 to screen Iron Rich materials.
- (7) 13-0163 approved 09/30/2014 for stack testing kiln #1 under alternative operating conditions.
- (8) 13-0176 approved 08/01/2016 to utilize electric arc dust with elevated cadmium.

This Title V permit includes RACT II requirements for NO<sub>x</sub>.

This TV permit renewal is based on information provided in BEFESA's (fka AZR) TV renewal application submitted on 09/25/18 and TV 13-00001 AMENDMENT for RACT 2 requirements issued on 03/25/2019 and PLAN APPROVAL #13-00001B issued on 10/22/20 for VOC limits on the Kilns.

BEFESA entered into a Consent Decree with EPA and PADEP in June 2021. Obligations in the Consent Decree may contradict permit conditions in this TV Permit. BEFESA is required to comply with the Consent Decree and the TV Permit.

Paragraph 118 of the Consent Decree requires that AZR submit an application for 'non-Title V' construction permits by June 2023 to incorporate appropriate Consent Decree requirements found in Consent Decree Paragraph 118a-g. Paragraph 119 requires BEFESA to apply to incorporate requirements of that permit into the TV permit.



\*\*\*\*\* End of Report \*\*\*\*\*

---